

**FEDERATION CYNOLOGIQUE INTERNATIONALE (FCI) (AISBL)**

*Place Albert 1<sup>er</sup>, 13, B – 6530 Thuin (Belgique), tel : +32.71.59.12.38, fax : +32.71.59.22.29, internet: [www.fci.be](http://www.fci.be)*

---

**RULES & GUIDELINES for  
OBEDIENCE TRIALS for  
CLASSES 1 & 2 & 3**



**January 1<sup>st</sup> 2016**

## CONTENTS

I	RULES ON ARRANGING, PARTICIPATING IN, MANAGING AND JUDGING OBEDIENCE TRIALS AND COMPETITIONS...	3
1.	Arranging official obedience trials and competitions .....	3
2.	National rules and guidelines concerning obedience trials .....	3
3.	Eligibility to participate in obedience classes .....	3
3.1	Health.....	4
3.2	Antidoping and vaccination regulations .....	4
3.3	Aggressiveness .....	4
3.4	Bitches in season and bitches in breeding .....	4
3.5	Changes in appearance .....	4
3.6	Spayed or neutered dogs .....	4
3.7	Examining the dogs .....	5
3.8	Other regulations .....	5
4.	Eligibility to judge obedience competitions .....	5
5.	Chief steward.....	5
6.	Management of the competition .....	5
7.	Handler's obligations and dog's equipment. ....	5
8.	Dog's behaviour / Disqualification.....	6
9.	Other regulations.....	6
II	PRACTICAL ARRANGEMENTS AND EQUIPMENT .....	7
10.	Layout of the competition .....	7
11.	Time allocated for judging per day and number of competitors .....	7
12.	Size of the obedience ring and quantities of the exercises .....	7
13.	Equipment.....	8
III	AWARDS AND MOVE-UPS.....	9
IV	EXERCISES AND COEFFICIENTS.....	10
V	GENERAL RULES AND GUIDELINES FOR PERFORMING AND JUDGING THE EXERCISES .....	12
14.	General guidelines for performing and judging all exercises .....	13
14.1	Performing the exercises.....	13
14.2	Judging the exercises .....	16
VI	RULES AND GUIDELINES FOR PERFORMING AND JUDGING THE INDIVIDUAL EXERCISES .....	19
CLASS 1	.....	19
CLASS 2	.....	26
CLASS 3	.....	36
APPENDIX 1.1	.....	50
APPENDIX 1.2	.....	51
APPENDIX 2	.....	52

Obedience (OB) training teaches a dog how to act in a co-operative and controlled way. Emphasis should be put on establishing good contact between the dog and the handler and on achieving the dog's willingness to obey even when at distance from the handler. Handler and dog should display a good overall relationship.

These rules and guidelines have been compiled to promote the sport of obedience and to support competition across national borders.

These rules and guidelines are applied at obedience trials in countries where the Kennel Clubs have chosen to follow them.

In international trials with CACIOB, the class 3 rules must be followed from 1.1.2016.

Results from other obedience trials with different performances, but which meet the corresponding requirements should be acknowledged.

## I RULES ON ARRANGING, PARTICIPATING IN, MANAGING AND JUDGING OBEDIENCE TRIALS AND COMPETITIONS

### 1. Arranging official obedience trials and competitions

Each national FCI member country decides what clubs and organizations are allowed to arrange official obedience trials and competitions.

### 2. National rules and guidelines concerning obedience trials

It is recommended that the Kennel Clubs publish on their website all necessary information concerning national rules, special national requirements, details of their legislation that influence animals entering their country and trials, as well as details such as entry fees and bank accounts, so that competing throughout all FCI member nations can be promoted. It is recommended that the handlers entering a competition should be informed of all necessary details concerning the competition and special national requirements by sending them a memo (data sheet).

### 3. Eligibility to participate in obedience classes

Eligibility to participate in obedience trials is defined by the regulations of the dog's home country and those of the country where the competition takes place. The national rules state what dogs are allowed to compete in obedience trials (classes 1 & 2 & 3). Eligibility to compete should be published on the website of the country.

The age at which class 1 can be entered should be stated in the national rules of each country. The dog should, however, be at least 10 months if not otherwise stated by the national rules of the country where the competition is arranged or the country in which the dog is registered. In class 3 the dog should be at least 15 months.

It is up to every country to decide what national obedience classes are recognized and what requirements need to be fulfilled before a dog is allowed to compete in a certain class. To participate in an international

obedience competition, however, the handler and the dog together should at least have passed the previous highest obedience class (class II or a class with corresponding exercises) (once) in their own country.

It is up to each country to decide how many times a dog may enter a class after having received its initial 1<sup>st</sup> price (Excellent). *This information should be available on the national www-pages.* If a dog has once entered a certain class level, it cannot enter a lower class.

### **3.1 Health**

Dogs that are blind, suffer from contagious diseases or infections or have hookworms, scabies or any other vermin, as well as dogs that are aggressive, may not participate in obedience trials. Dogs that are taped, stitched or bandaged are not allowed to participate.

### **3.2 Antidoping and vaccination regulations**

The national vaccination regulations and antidoping regulations must be followed according to the dog's home country and those of the country where the trial takes place. These should be published on the website of the country in which the competition takes place.

### **3.3 Aggressiveness**

Aggressive dogs are not allowed to enter the competition premises. The judge will disqualify any dog that attacks or attempts to attack a person or another dog. The incident is noted in the dog's working book and a report must be sent to the kennel club represented by the dog and the kennel club of the arranging country.

### **3.4 Bitches in season and bitches in breeding**

Bitches in season are allowed to compete in accordance to national rules of the country where the trial is held. *This information should be posted on the website of the country that arranges the trial.* Bitches in season must, however, perform last. They must be kept off the competition premises and nearby surroundings until all other dogs have completed their exercises.

A general rule would be that bitches expected to give birth within four weeks and bitches that have given birth less than eight weeks before the competition date must be excluded.

*National rules may state another tolerance. This information should be posted on the website of the country that arranges the trial.*

### **3.5 Changes in appearance**

Dogs with docked tails or cropped ears or ones that have had some other changes in appearance done for cosmetic reasons are admitted only in accordance with the legal regulations of the dog's home country and those of the country where the trial is arranged.

*All restrictions due to changes in appearance of the dog should be stated in the national rules and should be posted on the website of the country.*

### **3.6 Spayed or neutered dogs**

Spayed and neutered dogs are allowed to compete.

### 3.7 Examining the dogs

If necessary, the judge should check the dogs outside the ring before the start of the competition. *National rules might require that all dogs be checked.*

### 3.8 Other regulations

If an obedience competition is arranged in association with a dog show, there should be no requirement that the dog be entered in the dog show.

*National regulations should define what specific registration and club membership is required.*

## 4. Eligibility to judge obedience competitions

Judges for obedience competitions should have sufficient training in judging obedience and be licensed by the kennel club of their own country.

(The qualifications and language skills of judges invited from other countries should be checked by their national Kennel Club.)

Ineligibility due to the likelihood of bias: *National regulations define ineligibility due to the likelihood of bias.* At international competitions with CACIOB, the FCI ineligibility rules should be followed.

## 5. Chief steward

A chief steward must be appointed for the competition. The chief steward is responsible for the practical arrangements of an obedience competition and must have appropriate qualifications. A qualified steward should direct the exercises in classes 2 and 3. It is also recommended in class 1. If competitors from abroad enter the competition, it is recommended that a mutual language for directing the exercises is agreed upon beforehand. In class 3 the steward must be able to conduct the exercises in English or a language mutually agreed upon.

If the exercises are divided and judged by two or more judges, there should be an equal number of stewards. There should be at least one steward per ring.

## 6. Management of the competition

Obedience competitions are under the management of the (chief) judge of the day and the chief steward. If there is more than one judge in a competition, one of the judges is appointed chief judge and chairman of the judging team.

If incidents occur that are not dealt with in these regulations and directions, the judge (or team of judges lead by the chief judge) decides how to proceed or how to evaluate the incident.

## 7. Handler's obligations and dog's equipment.

A handler's obligations as a competitor start when the handler enters the competition premises and end after the final prize-giving ceremony. Handlers must follow the rules and directions as instructed. Handlers are expected to be on their best behaviour and appropriately dressed.

The judge may disqualify a handler from the competition if he or she does not abide by the rules or behaves in an unseemly way. The judge's decision is final and no competitor shall impugn the decisions of the judge.

Handlers should report their presence at the competition premises 30 minutes before the obedience competition begins.

It is forbidden to punish the dog.

Only ordinary collars (buckled or slip collars) are permitted. Barbed or electric collars and other constraining devices or means, such as muzzles are forbidden. This restriction begins at the start of the competition until the end.

Blankets, mantles, harnesses, raincoats, shoes, stockings, bandages, tapes, etc., on the dog are forbidden during the performance.

The handler should have the dog on the left side during and between the exercises. If there is a physical reason or disability, the handler is allowed to have the dog on the right side during or between the exercises. The competitor or team leader of this combination must discuss the arrangement with the referee judge before the start of the competition, however. All judges concerned must be informed and the effect this has on evaluating the performances must be agreed on if there are several judges involved. Any exceptional arrangements should be justified and should not cause disturbance to other dogs and competitors. For example, if a competitor is in a wheelchair, he or she should, in group exercises be placed the end of the line so that no other dog is passed.

## 8. Dog's behaviour / Disqualification

A dog that at any time during the competition (before, during or after its own performance) bites, tries to bite, attacks or tries to attack people or other dogs, is disqualified from the competition. All points are lost even if the performance has already been completed. In a two-day event, the disqualification is valid also for the second day and thus the dog cannot compete.

The incident is noted in the dog's working book and a report must be sent to the kennel club that the dog represents and the kennel club of the arranging country.

*In addition to the actions mentioned above, national regulations should be followed.*

## 9. Other regulations

When the competition ring is being built and after it has been built for the competition, a handler is not allowed to enter the competition ring together with his dog unless an authorized person (the chief steward or judge) has given permission.

In the group exercises (Exercises 1) of classes 1 and 2, the minimum number of dogs in a group is three and the maximum six. In a competition where the number of dogs is not divisible by six, the judge can arrange two groups of seven dogs. In class 3 the minimum number of dogs in the group exercises (Exercises 1 & 2) is three and maximum four, with the exception of there only being five dogs altogether in class 3.

## II PRACTICAL ARRANGEMENTS AND EQUIPMENT

### Layout, number of competitors, size of the ring and equipment needed

#### 10. Layout of the competition

The judge (chief judge, referee judge, chairman of the judging team) has the right, having consulted the organizing committee, to decide in which order the exercises will be done during the competition and how the exercises are grouped together. The order should be the same for all competitors.

#### 11. Time allocated for judging per day and number of competitors

The competition should be so planned that the judging appointment does not take more than approximately five hours per day.

*National guidelines of the country where the competition is arranged should be followed.*

It should be noted that the time needed to judge a particular number of dogs depends on the layout of a competition, the steward, the judge and the breeds that have been entered.

Approximations of judging times:

##### Class 1

It is recommended that a judge does not judge more than approximately 30 dogs per day in class 1. Judging 6 dogs takes approximately one hour.

##### Classes 2 and 3

It is recommended that a judge does not judge not more than 25 dogs per day in classes 2 and 3. It is estimated that judging 7 dogs takes approximately two hours.

If more than one judge is appointed, each judge judges the exercises appointed to him for all dogs entering. In this case the number of dogs can be more.

#### 12. Size of the obedience ring and quantities of the exercises

The size of the obedience ring for an indoor competition should be at least 20 m x 30 m in classes 2 and 3. When the competition is outdoors, the preferred ring size is at least 25 m x 40 m. In class 1 the ring can be slightly smaller. The ring can also be smaller if the exercises are divided among two or more rings and those exercises requiring less space are grouped together. The ring should be clearly marked. It is up to the judge to decide whether the ring size is acceptable or not. All numerical values of the quantities in the exercises are approximations.

## 13. Equipment

It is the responsibility of the organizing committee to keep the following equipment as well as the rules and guidelines and other necessary instructions available at the competition premises.

Hurdles:

- A boarded hurdle approximately 1 m wide and adjustable in height from about 10 cm to 70 cm at intervals of 10 cm is required. The side bars should be approximately 1 m. In contrast to an agility fence the hurdle should not have side wings. Such a hurdle is needed in all classes.
- An open hurdle approximately 1 m wide and adjustable in height from approximately 10 cm to 70 cm. The side bars should be approximately 1 m high. The hurdle should be constructed so that it is open i.e. there is only one board of approximately 3-5 cm high or a round bar of approximately 3-5 cm in diameter at the required height and a thin support bar connecting the feet/sidebars at the bottom. There should be supports only for the bar and the supports should be placed so that the dog can drop the bar regardless of the direction from which the dog is jumping. The supports should be slightly concave (spoonlike) so that the wind does not drop it. The hurdle should not have side wings. This hurdle is needed for class 3 in addition to the one described above.

See figures and description of the hurdles in the appendix 1.

Suitable retrieve objects:

- Three series of wooden dumbbells.  
Each series includes three dumbbells of equal size for class 3.  
For class 2 only two of these are needed  
For class 1 only one of each size is needed.  
Each series differs in size and weight so as to suite different-size breeds i.e. small, middle- size and large breeds. The weight of the largest should not be more than approximately 450 g. The handler can choose whatever size he/she prefers, however.
- Metal dumbbells of three different sizes with a maximum weight of approx. 200 g for the largest. The sizes of the dumbbells available should be in proportion to the sizes of breeds (small - medium - large). The handler can choose whatever size he prefers, however.
- Wooden objects approx. 2 cm x 2 cm x 10 cm are needed for classes 2 and 3.
  - In class 2, the number of objects is six times the number of competing dogs
  - In class 3, the number of objects is eight times the number of competing dogs.

Other equipment:

- Charts by which the points awarded are shown should be available.
- Charts on which the positions of the distance control are written or drawn or an electrical display board.
- Chalk, spray paint, tape strands or equivalent means that can be used for marking e.g. the squares and circles as well as starting points/ending points.



- A sufficient number of markers and cones must be available to indicate for example the starting and ending points of the exercises, when necessary, and the places of performance such as turning sites, etc.

The markers and cones should be appropriate and suitable. In choosing their size, visibility and colour, their function should be considered i.e. are they meant for the dog, handler and judge or steward.

For example the cones for the corners of the squares should be approx. 15 cm and visible.

The stopping point for exercise 6 in class 3 may be indicated by a small marker (a disc with a diameter of approximately max 10 cm or a square which side is max 10 cm) and the stopping point for exercise 7 in class 3 must be indicated by a cone of approximately 10 - 15 cm.

There should also be an approximately 15-40 cm high cone for exercise 10 in class 1 and an approximately 40 cm high cone for class 3.

### III AWARDS AND MOVE-UPS

#### Classes 1 & 2 & 3

1 <sup>st</sup> prize	256 – 320 points	80 % Excellent
2 <sup>nd</sup> prize	224 – under 256 points	70 % Very good
3 <sup>rd</sup> prize	192 – under 224 points	60 % Good

A dog that has achieved excellent (1<sup>st</sup> prize) in a class, in any country, is allowed to move up to the next class.

It is up to the national rules to state how many starts are allowed in a class after the dog has achieved its first excellent.

A dog is, however, allowed to compete in a class until it has achieved 3 x excellent / country.

It is up to the national guidelines to decide what trophies, diplomas, ribbons or rosettes are awarded.

The colours of the obedience ribbons and rosettes, however, have traditionally been black - red - yellow.

If two or more dogs end up with the same number of points and if it is desirable to have a final line-up, the results of exercises 3, 5 and 6 should be added together. If the addition gives the same results, these three exercises should be repeated.

## IV EXERCISES AND COEFFICIENTS

It is recommended that national obedience programmes include a novice/beginners' class that the dogs should pass before entering class 1.

<b>CLASS 1</b>	<b>Exercise</b>	<b>Coeff.</b>
1.	Sitting in a group for 1 minute, handlers in sight	3
2.	Heelwork	3
3.	Stand under march	3
4.	Recall	3
5.	Sit or down under march	2
6.	Send away into a square and lying down	3
7.	Retrieve of a wooden dumbbell	4
8.	Distance control	3
9.	Recall and jumping over a hurdle	3
10.	Send around a cone and return	3
11.	General impression	2
	$\Sigma$	32
<b>CLASS 2</b>	<b>Exercise</b>	<b>Coeff.</b>
1.	Lying in a group for 2 minutes, handlers out of sight	2
2.	Heelwork	3
3.	Stand / sit / down under march (two of these three positions)	3
4.	Recall with stand	4
5.	Send away with down and recall	4
6.	Directed retrieve	3
7.	Scent discrimination and retrieve	4
8.	Distance control	4
9.	Jumping a hurdle and retrieving a metal object	3
10.	General impression	2
	$\Sigma$	32

<b>CLASS 3</b>	The rules and guidelines of class 3 should be applied at International obedience competitions, where a CACIOB and reserve CACIOB can be awarded as well as World and Section Winner competitions. These rules are effective from 1.1.2016.	
	<b>Exercise</b>	<b>Coeff.</b>
1.	Sitting in a group for 2 minutes, handlers out of sight	<b>2</b>
2.	Lying in a group for 1 minute, and recall	<b>2</b>
3.	Heelwork	<b>3</b>
4.	Stand, sit and down under march	<b>3</b>
5.	Recall with stand and down	<b>4</b>
6.	Send away with directions, down and recall	<b>4</b>
7.	Directed retrieve	<b>3</b>
8.	Send around a cone, positions, retrieving and jumping a hurdle	<b>4</b>
9.	Scent discrimination and retrieve	<b>3</b>
10.	Distance control	<b>4</b>
		<b>Σ 32</b>

## V GENERAL RULES AND GUIDELINES FOR PERFORMING AND JUDGING THE EXERCISES

The regulations and guidelines for performing and judging the exercises comprise of

- A) A general part which concerns performing and judging all exercises in class 1 and 2 and 3.
- B) A part which describes the performing and judging of the individual exercises.

If not otherwise stated in the individual exercises, these general regulations and directions for performing and judging the exercises are applied to all exercises.

If incidents occur that are not covered in these regulations and guidelines, the judge decides how to proceed or how to evaluate. The judge's decision is final and no competitor shall impugn the decisions of the judge.

### Points awarded

The obedience performances are graded as follows:

0 – 5 – 5½ – 6 – 6½ – 7 – 7½ – 8 – 8½ – 9 – 9½ – 10.

Disqualification leads to termination of the performance and loss of all points awarded. The dog may not continue with the remaining exercises of the competition.

Failing an exercise leads to loss of all points in the specific exercise. The dog may continue with the remaining exercises.

### The use of yellow and red cards

In class 3 yellow and red cards are used.

The yellow card indicates a warning. The judge can give a warning on the basis of the handler's or dog's actions.

If the judge shows the yellow card 10 points are reduced from the final score. If the judge shows a yellow card twice disqualification follows.

The red card indicates disqualification.

### The use of red/yellow cards in competitions with several judges:

1) Two or more judges in separate rings

- When two judges are judging separately (two rings, different exercises), one red card (the first) leads to disqualification.
- If one of the judges has shown a yellow card e.g. in the first ring, the other judges (second or third judge) should not be informed of this. All judges work independently. The yellow card is written down and if a yellow card is shown by a latter judge (second or third) the secretary writes it down and then informs the judge that one yellow card has been shown earlier and disqualification will thus follow. Naturally two yellow cards given by the same judge leads to disqualification as well.

2) Two or more judges in the same ring

If one of the judges wants to warn (yellow card) or disqualify (red card) a competitor, he/she informs the other(s) and the matter will be decided on together. Preferably the chief judge (chairman of the judging team) will show the card, if he/she is in the ring.

## 14. General guidelines for performing and judging all exercises

These guidelines are followed in all exercises if not otherwise stated in the description of the exercises.

### 14.1 Performing the exercises

1. National rules can state that all dogs must be checked before they are allowed to enter the ring and might also state that the judge should be allowed to handle/touch the dogs.
2. The judge can choose in what order the exercises are performed. The order should be the same for all competitors.
3. The exercises begin and end with the dog in heel position. The heel position is defined as the sitting position at the handler's left side.
4. The handler walks at normal pace in all exercises except for heelwork. The heelwork can also include a fast and slow pace depending on the class.
5. All exercises begin when the steward has directed the handler and dog to the starting place and the dog sits in starting position and the steward has announced "Exercise starts" or "Exercise begins".
6. The handler should command his/her dog to heel position at the starting point and be ready to start the exercise within a very short time. In class 1 the tolerance can be slightly more than in classes 2 and 3 where the handlers should be prepared to have their dogs in heel position and start the exercise very shortly after having reached the starting point.
7. All exercises are over when the steward has announced "Exercise ended" or "Thank you".
8. In all exercises, if not otherwise stated in the exercises, the steward gives the permission to the handler to command the dog in all phases of the exercise, even if it is not systematically written down in all exercises.
9. It is up to the handler to decide whether or not to give a second command and when to give it.
10. The steward's commands mentioned in these regulations are just examples. It is important that the commands are clear to the handlers.
11. It is not allowed to point out or show places and directions to the dog before, at the starting point or during exercises (other than those relating to the ongoing exercise, if such are allowed). Such activity will lead to failure of the exercise.
12. In class 1 the handler may enter the ring with the dog on leash. During the whole performance the handler must keep the leash invisible to the dog. The handler may also leave it at the steward's desk or outside the ring. He/she may put the leash on the dog after the performance when he/she leaves the ring.
13. In classes 2 and 3 the handler must leave the dog's leash outside the ring or at the steward's table. This applies to all exercises.
14. The dog should be on the handler's left side between the exercises. The dog does not have to be in heel position and under command, but it should be beside the handler and under control. If for some reason or other there is a delay when moving from one exercise to the next, it is allowed to command the dog down, but it should not be recalled from this position to continue with the exercises.

15. The handler should move normally using straight paths. Indefinite or ambiguous movement, exaggerated gestures, signals or body language and unnatural movement of the extremities are penalised. Turns and turnabouts should be 90° and 180° and after turnabouts the handler should return approximately using his original path.
16. In exercises where the dog is passed the distance between the dog and the handler should be approximately 0,5 m. The handler may pass the dog from either side if not otherwise stated in the exercise.
17. The directions right and left (e.g. in directed retrieve) are defined from the handler's viewpoint, i.e the handler looking to his/her righthand side or lefthand side when directing the dog at the starting point.

In the group exercises, however, the direction is from left to right when facing the dogs in front of the lineup. 1 = left ..... 4 = right.

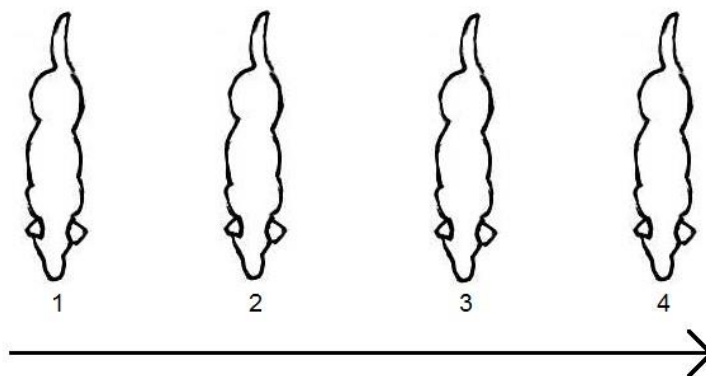

18. The handler is not allowed to touch the dog or stroke it or give other forms of encouragement during the exercises. Such behaviour will result in failure of the exercise. Slight encouragement (e.g., saying "well done - well done" or giving a few gentle pats) is allowed after the exercise has been completed.
19. Tit-bits or playing tools such as balls or toys are not allowed in the ring, neither during nor between exercises. If the judge observes that a competitor has or uses tit-bits or playing tools in the ring, he or she will be disqualified.
20. In directing exercises the handler is not allowed to show directions or touch the dog at the starting point. This will fail the exercise.
21. In the case of excessive encouragement, playing or fooling around, jumping into the arms of the handler, weaving around the handler's legs, etc., the judge will warn the competitor and
  - in classes 1 & 2 the judge will note this behaviour in the general impression
  - in class 3 the judge will show the yellow card.
  - in all classes a second incident will disqualify the dog.
22. The judge has the right to stop an exercise if the dog shows obvious incapability or unwillingness to perform it. Such an exercise is failed.
23. The judge has the right to bar a dog from further participation in the competition if it isn't functioning properly or if it is causing disturbance by continuous barking or whining.
24. Barking and whining during an exercise also has an influence on the received points.

25. In case of barking or whining both during and between exercises, the judge can give a first warning and
- in classes 1 & 2 note this behaviour in the general impression
  - in class 3 show the yellow card

If the behaviour continues the judge will disqualify the dog.

26. The height of all jumps should not be more than approximately the height of the withers of the dog and thus the height of the hurdles should be raised or lowered correspondingly.

### **Heelwork**

27. The heelwork in all classes is performed without a leash.
28. The unleashed dog should willingly follow the handler, walking on the handler's left side, with its shoulder level with the handler's left knee and following the handler in a parallel line. The handler should move his arms and feet in a natural way during the exercises.
29. In the heel exercises the handler can choose to do the turnabouts (180° turn) to the left or to the right. The "German turnabout" is equally acceptable (the dog is allowed to circle around the handler very tightly on the right side. The handler should, when making a turnabout, return approximately along the same line that he/she came.
30. Turns to the left and right during the heelwork should be right angles (90°). The handler should not turn his head, should not twist his shoulders or use any other body language or give signals with his feet.
31. The "Heel" command may be given at every start, when changing speed and when taking steps in different directions and at turns and turnabouts from a standing position.
32. When the handler stops, the dog should take the heel position immediately and without command.
33. In walking backwards, the longer distances in classes 2 & 3, this should start from a heel position (a stop) and end in a heel position.

### **Commands and hand signals:**

34. The commanding words given in these guidelines are recommendations. Other sufficiently short words are acceptable as commands.
35. The "Heel" command may be given at every start and the command "Stay" is allowed in exercises in which the handler leaves the dog or turns away from the dog.
36. Commands are verbal commands. In some instances hand signals can substitute a verbal command or be given simultaneously with a verbal command. If so, it will be stated in the exercise. When using hand signals they should be short and not outlast a verbal command and not include any other body language. One hand or two hands may be used.

In exercises where commands or signals are allowed, the handler must inform the judge before the exercise commences if hand signals will be used. This is not necessary if both voice commands and hand signals are allowed.

37. The concept body language means moving your body (not necessarily taking steps), twisting or turning the body, the head or shoulders as well as giving signals with your feet. This reduces points according to gravity and situation.
38. Taking steps when commanding will fail the exercise.

39. Hand signals are never allowed when the dog is beside the handler in heel position. This will cause a strong reduction of points, the reduction being 2-4 points depending on strength, situation and duration. If body language is included the reduction is always even more.
40. In exercises where the dog is directed or needs to be redirected, hands signals are allowed simultaneously with a voice command when the dog is at a distance. This is indicated by square brackets [ ]. Such exercises or parts of exercises are: running around the cone, directing into a circle and into a square and directing to retrieve the correct dumbbell. Reducing points for a simultaneous hand signal should not be done, only for the extra commands or redirecting commands.

#### **Recall and retrieving exercises:**

41. The dog's name may be combined to the command in all the recall exercises / all recall situations. The name and the command have to be tied closely together so that the name and command do not give an impression of two separate commands. It is also allowed to use just the dog's name.
42. In the recall and retrieving exercises the dog is allowed either to come directly to the heel position or to come and sit in front of the handler first. If sitting in front of the handler, the dog must, on command (after permission from the steward), quickly take its heel position, passing the handler very closely. This also holds for jumping the hurdle.
43. In the recall and retrieving exercises, the judge does not need to know whether the dog was intended to take the heel position directly or after sitting in front. If the exercise is elegantly performed, full points can be awarded regardless of what was intended.
44. If a dumbbell is unintentionally thrown to an unsatisfactory place (bumps outside the ring or to a place where it can't be reached, or too short a distance), it must be thrown again. This however results in a reduction of 2 points. If the second throw is not successful the exercise is failed.
45. It is not allowed to let the dog take hold of the object / dumbbell before the exercises. If this occurs, not more than 5 points can be awarded in class 1 and in classes 2 & 3 the exercise is failed.
46. The handler is free to choose the size of the dumbbell they will work with.

#### **14.2 Judging the exercises**

47. Judging of an exercise starts when the handler has taken his position at the starting point with the dog being in the heel position, and the stewards says "Exercise starts". Judging of an exercise ends when the steward has announced "End of exercise" or "Thank you".
48. All deviations from the ideal should reduce points: all extra commands, double commands, body language, deviations at heel position and deviations from parallel movement, etc.
49. It is important that the dog is happy and willing to obey the commands.
50. In judging speed and tempo, the breed should be taken into consideration. The ideal for all breeds is not the same. When a dog reacts on the commands instantly and willingly, moves typically to his breed, keeps his pace and shows an interest in what it is doing, the dog should be awarded with full points if there are no lowering mistakes.
51. A general rule is that for a second command 2 points should be reduced and a third command fails the exercise, or in some cases a part of it. For example sitting at the end of an exercise, a position of the directed retrieve exercises, or a position of the exercises 2.3 and 3.4. In exercises with directing commands and distance control commands, 1-2 points are reduced for a second command. See the directions of these exercises.
52. All punishment of the dog leads to disqualification.



53. If the handler touches the dog during the exercise, the exercise is failed (0 points). This may lead to a warning.
54. If touching the dog during or between exercises can be interpreted as punishment, the handler and the dog are disqualified.
55. If the dog does not take the heel position or starting position of an exercise (i.e. sit or down), the exercise is failed (0 points).
56. If a dog does not take its heel position (sit) at the end of an exercise no more than 7 points can be awarded.
57. If the dog does not sit calmly beside the handler at the start of an exercise, no more than 8 points can be awarded.
58. If the handler takes steps when giving commands, the exercise is failed (0 points).
59. If a dog touches the handler (slightly, lightly) in the recall or retrieving exercises when sitting in front of the handler or coming to heel position / moving to the side of the handler, 1-2 points should be reduced. If it bumps into / collides with the handler, no more than 7 points should be awarded.
60. Barking even occasionally or whining during an exercise reduces points. No more than 7 should be awarded in the case of barking, and if the dog barks extensively or continuously the exercise is failed (0 points). Even if there is only one very short bark in the beginning (or end) of the exercise, maybe expressing enthusiasm, at least 1 point should be reduced. If the barking is continuous and is repeated in several exercises the performance is disqualified. The same holds for whining.
61. Controlling the dog by the collar between exercises leads to a warning and to a reduction of points in the general impression and in class 3 to a yellow card.
62. If the dog relieves itself in the ring:
  - in class 1 during an exercise, the exercise is failed (0 points) and the general impression is failed (0 points).
  - in class 1 in-between the exercises, the general impression is failed (0 points).
  - in classes 2 & 3 during or in-between exercises, the dog is disqualified.

#### **Anticipating the command or starting the exercise too early**

63. If a dog anticipates the command (i.e. does not keep the heel position properly: jerks, stands up, but does not take steps forward) when starting the exercise, no more than 8 points can be awarded.
64. In class 1, (in exercises where the dog is sent away from the handler) if the dog leaves the handler (starts the exercise) after the exercise has started but before the command of the handler (for example on command of the steward), the handler may call the dog once. If it returns and fulfils the exercise max 6 points can be awarded. If it does not return, but continues with the exercise, the exercise is failed (0 points).
65. In classes 2 & 3 if the dog starts the exercise (leaves the handler) before command, there is no possibility for recall and the exercise is failed (0 points).

#### **Leaving the ring or leaving the handler**

##### ***Leaving the ring***

66. In classes 2 & 3, if a dog leaves the ring during or between the exercises and is out of control, it is disqualified.

67. In class 1, if the dog leaves the ring during or between the exercises being out of control, the handler is allowed to call the dog twice. If it returns, they may continue with the competition, but this will be noted in the general impression and cause a severe reduction of points. The exercise concerned is failed (0 points). If the dog leaves the ring a second time, disqualification follows.

***Leaving the handler without leaving the ring***

68. In classes 2&3, if the dog leaves the handler during an exercise (interrupts the exercise) or between exercises and is out of control, but does not leave the ring, the handler may call the dog (once) without leaving his/her position. If the dog returns to the handler the exercise concerned is failed (0 points), but the dog and handler can continue with the next exercise.

In class 2 this causes a severe drop of points in the general impression.

In class 3 this leads to a warning. The judge will show a yellow card.

If the dog does not return, or if the dog leaves a second time, disqualification follows (both classes 2 & 3). In class three the judge will show a red card.

69. In class 1 if the dog leaves the handler during an exercise or between exercises and is out of control, the handler may call the dog twice without leaving his position. If the dog returns to the handler, they may continue with the competition, but this will be noted in the general impression and cause a severe reduction of points. The exercise concerned is failed (0 points). If the dog leaves the handler a second time, disqualification follows.

**Retrieving exercises**

70. *Dropping the dumbbell/object:*

If the dog drops the dumbbell/object, but picks it up on its own initiative, no more than 7 points can be awarded. If an extra "retrieve" command has to be given before the dog picks up the dropped dumbbell/object, the maximum is 5 points. If the dog drops the object beside the handler and the handler picks it up without taking a step, 5 points can be awarded presuming the dog takes the heel position correctly. If the object is dropped, due to the handler's carelessness after the release command, no more than 7 points can be awarded.

71. *Chewing or biting on the dumbbell/object*

Chewing or biting on the dumbbell/object is penalised by a reduction of 2-3 points. If chewing is extensive not more than 5 points can be awarded. Very extensive chewing or breaking the dumbbell/object results in failing the exercise (0 points). No penalty should be given, however, if the dog once takes a better grip on the dumbbell/object.

## VI RULES AND GUIDELINES FOR PERFORMING AND JUDGING THE INDIVIDUAL EXERCISES

### CLASS 1

#### **EXERCISE 1.1**      **Sitting in a group for 1 minute, handlers in sight**      **[Coeff. 3]**

**Commands:**      “Sit”, “Stay”

**Performance:**      The exercise starts when all handlers of the group stand in a row at approximately 3 meters distance from each other with their dogs in heel position and the steward announces “Exercise starts”. The exercise ends when the handlers have returned to their dogs and the steward has announced “Exercise over”.

The handlers leave their dogs and walk approximately 25 meters to the ringside and turn to face their dogs. When 1 minute has elapsed, they walk back towards their dogs, pass their dogs at a distance of approximately 0,5 m, take a standing position approx. 3 meters behind their dog after which the handlers are instructed to walk up beside their dog.

There should be at least three dogs in a group, but no more than six.

**Directions:**      A dog that fails to sit (two commands), stands up, lies down or moves more than its own body length gets 0 points. All moving reduces points. If the dog barks 1-2 times, 1-2 points are withdrawn; if it barks most of the time, the exercise is failed (0 points). Restlessness, such as shifting weight from one side or one foot to another, reduces points. The dog is allowed to turn its head and look around, and it is allowed to show interest if there is a distraction or a noise inside or outside the ring. This, however, should not give an appearance of restlessness or anxiety. If the dog lies down or stands up after the one-minute period is over and the handlers are moving towards their dogs, no more than 5 points can be awarded. If a dog stands up and goes close to another dog, so that there is fear for severe disturbance or a fight, the exercise must be stopped and then resumed for all the dogs except for the dog that caused the disturbance.

#### **EXERCISE 1.2**      **Heelwork**      **[Coeff. 3]**

**Command:**      “Heel”

**Performance:**      Heelwork is tested at normal pace in conjunction with turns to the left and to the right, turnabouts and halts. Heelwork is also tested in fast pace, but only right turns should be included. The dog must also be tested when the handler moves two or three steps forwards and backwards. *The general directions describe heelwork in more detail.*

All dogs in one trial or competition should do the heelwork according to the same scheme.

**Directions:**

A dog that leaves the handler or follows the handler at a distance of more than half a meter during a major part of the exercise, fails the exercise. If the dog moves slowly, only 6-7 points should be given. Lack of contact and extra commands are mistakes. An imperfect direction (not parallel) of the heel position should result in loss of about 2 points. Slowing down and stopping before, during or after turns will reduce points. Points should be reduced if a dog walks very near the handler so that it disturbs or hinders the handler, even more points should be dropped if the dog leans and touches the handler.

**EXERCISE 1.3**

**Stand under march**

**[Coeff. 3]**

**Commands:**

“Heel”, “Stand”, “Sit”

**Performance:**

Handler and dog leave the starting point walking in a straight line at a normal pace. After approximately 10 meters the handler commands the dog, without stopping, to stand and the dog must stop immediately. The handler walks approximately 10 meters (place indicated e.g. by a marker or cone), turns around (independently) and stands facing the dog. After approximately three seconds, on the steward's permission, the handler returns towards the dog along a parallel path that he/she left, passing the dog at a distance of approximately 0,5 meter, leaving the dog on her/his left side, turns around when he/she has passed the dog (1-2 m) and returns beside the dog and commands the dog to heel position. All phases of the exercise, except turning around at the marker/cone, are done on the steward's permission.

**Directions:**

If the dog stops in a wrong position, changes a correct position before the handler has turned around, stands before the command, needs an extra command or if the handler stops before / when commanding the dog, no points can be awarded. To get any points the dog should not move more than one body length after the command. A dog that stops immediately at command, but in a wrong position, can be awarded 5 points if the exercise is perfect in all other aspects.

If the dog changes a correct position after the handler has turned around at the cone/marker, no more than 7 points should be awarded. If the handler changes pace / slows down / speeds up before his command no more than 7 points can be awarded. Hand signals and body language on the stand command are grave mistakes, and will severely drop points, depending on their strength and duration the reduction should be 3-5 points.

In judging, attention should be paid to the heelwork as well. For bad heelwork the reduction should be 1-2 points. Moving and stopping slowly or not stopping in a straight position are mistakes. The reduction should be 1-4 points. If the handler passes the dog from the wrong side 1 point should be reduced.

## **EXERCISE 1.4**

### **Recall**

**[Coeff. 3]**

**Commands:** “Down” (“Stay”) “Come” (“Heel”)

**Performance:** The handler commands the dog down (on steward’s permission) and starts walking (on steward’s permission) 20 – 25 m in the indicated direction to the indicated place and turns around (independently). On permission from the steward, the handler recalls the dog. The dog’s name may be combined with the recall command, but name and command must be well combined together and may not give the impression of two separate commands.

**Directions:** It is important that the dog responds willingly to the recall command. The dog should move at good speed and keep its pace, at least a fast trot. A reluctant approach is a mistake. The breed should be taken into consideration in judging the speed. If more than one recall command is given, no more than 7 points should be awarded. A third recall fails the exercise. If the dog moves more than one body length before the recall command, the exercise is failed. If the dog stands or sits up or moves less than one body length before told, no more than 8 points can be awarded.

## **EXERCISE 1.5**

### **Sit or down under march**

**[Coeff. 2]**

**Commands:** “Heel”, “Sit” or “Heel”, “Down”, “Sit”

**Performance:** The handler must inform the steward and judge which one of the two alternative positions (sit/down) the dog will take. Handler and dog leave the starting point walking in a straight line at a normal pace. After approximately 10 meters the handler commands the dog, without stopping, to sit / lie down and the dog must sit /lie down immediately. The handler walks approximately 10 meters (the place indicated e.g. by a marker or cone), turns around (independently) and stands facing the dog. After approximately three seconds, on the steward’s permission, the handler returns towards the dog along a parallel path that she/he left, passes the dog at a distance of approximately 0,5 a meter, leaving the dog on her/his left side, turns around when she/he has passed the dog (1-2 m) and returns beside the dog /and commands the dog to heel position. All phases of the exercise, except turning around at the marker/cone, are done on the steward’s permission.

**Directions:** If the dog stops in a wrong position, changes a correct position before the handler has turned around, sits / lies down before command, or needs an extra command, or if the handler stops before / when commanding the dog, no points can be awarded. To get any points the dog should not move more than one body length after the command. A dog that stops immediately at command, but in a wrong position, can be awarded 5 points if the exercise is perfect in all other aspects.

If the dog changes a correct position after the handler has turned around at the marker/cone, no more than 7 points should be awarded. If the handler changes pace / slows down / speeds up before his command no more than 7 points can be awarded. Hand signals and body language on the sit /down command are grave mistakes, and will be severely drop points. Depending on the strength and duration of these mistakes 3-5 points should be reduced.

In judging, attention should be paid to the heelwork as well. For bad heelwork the reduction should be 1-2 points. Moving and sitting / lying down slowly or not sitting straight /lying straight are mistakes. The reduction should be 1- 4 points. If the handler passes the dog from the wrong side 1 point should be reduced.

## **EXERCISE 1.6**

### **Send away to a square with down**

**[Coeff . 3]**

#### **Commands:**

“Forward”, [“Right/left” and/or hand signal], (“Stand”), “Down”, “Sit”

#### **Performance:**

Before starting the exercise, the handler should inform the judge whether he/she will command the dog first to stand and then to lie down in the square or to lie down directly in the square.

When the steward gives permission, the handler directs the dog into a square of 3 m x 3 m which is located approximately 15 meters from the starting point. The dog should move in a straight line to the square and should enter the square from the front.

When the dog reaches the square, the handler commands the dog either to stand and then to lie down or directly to lie down. If the dog is commanded to stand, the stand position should be clear and stable, before the down command is given. When told, the handler walks up beside the dog and commands (after permission from the steward) it in heel position.

The handler should not use more than four commands during this exercise, the fourth command being a stand command in the square. Alternatively the handler can command the dog directly to lie down and thus use only three commands. If the dog has to be redirected, handsignals may be combined to the directing command.

The size of the square is 3 X 3 m. The distance between the middle of the square and the starting point is approximately 15 metres. Cones (approx. 10 - 15 cm high) mark the square at each corner. Visible lines (e.g. tape, chalk lines, bands) should connect the cones on their outer side. There should be at least an approx. 3-5 meters distance from the borders of the square to the nearest ring borders. See figure for ex. 6 of class 1.

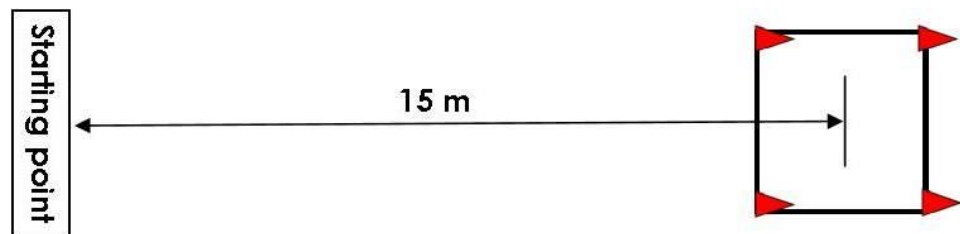

## **Directions**

The dog's willingness to follow the commands, the dog's tempo and a straight route should be emphasised. To get 10 points, the handler should not use more than four commands during this exercise, the fourth command being the stand command in the square. Alternatively the handler can command the dog directly to lie down and thus use only three commands.

If the handler moves (takes steps in any direction) while giving the commands, the exercise is failed (0 points). If there is excess action (body language), no more than 8 points should be given. If the dog moves very slowly, only about 7 points should be given. If the dog acts on his own points are reduced (i.e. if the dog stops or lies down without a command).

To get points, the dog's whole body, except for the tail, must be inside the square. If the dog sits or lies down outside the square, it cannot be redirected and the exercise has failed.

The exercise is failed (0 points) if the dog moves out of the square before the end of the exercise. If the dog creeps in the square, no more than 7 points can be awarded. If the dog changes position before the handler has reached it, no more than 6 points can be awarded.

If the dog takes the wrong position in the square 3 points are reduced and if the standing position is not clear and stable 2 points are reduced. The exercise is failed (0 points) if one of the stand or down commands has to be given a third time. For the second stand and down command the reduction is 2 points. The reduction of points for extra directing/redirecting commands depends on their strength and the dog's willingness to obey the commands and thus the reduction can be 1 or 2 points. No more than 8 points can be awarded, if the dog rises to sit or stand before command when the handler is beside the dog.

It is not allowed to show the dog directions at the starting point or to show the square to the dog before the exercise. This will lead to failing the exercise.

## **EXERCISE 1.7**

### **Retrieve**

**[Coeff . 4 ]**

#### **Commands :**

"Retrieve" and "Release", ("Heel")

#### **Performance:**

The steward announces the start of the exercise and hands the handler the wooden dumbbell. The handler throws the dumbbell on the steward's command to a distance of at least approximately 10 m. When instructed, the handler commands the dog to retrieve the dumbbell.

#### **Directions:**

Emphasis should be on the dog's willingness to follow the commands, the dog's tempo and its taking the shortest ways to the dumbbell and back.

*For dropping the dumbbell and for chewing or biting on the dumbbell see the general guidelines for judging exercises.*

### **EXERCISE 1.8**

### **Distance control, sit /down, 4 changes**

**[Coeff . 3]**

#### **Commands:**

“Down” “stay”, “Sit”, “Down” and / or hand signals.

#### **Performance:**

The dog should change positions four times (sit/down) according to the handler's commands and remain in its original place. A boundary is formed in back of the dog by an imaginary line connecting two markers. The handler commands his/her dog to lie down at the starting point in front of the boundary. The handler leaves the dog and moves to an assigned place approx. 5 m in front of the dog, facing the dog. The order of taking the positions are only sit - down (two times) and thus the last command for changing position should be “down”. The steward shows the handler in which order the dog should change positions using written signs or drawings or an electrical display board. The steward should stand approximately 3-5 m from the dog so that he/she is not able to see the dog when displaying the instructions. The steward should change the sign about every 3 seconds. The handler may use both voice commands and hand signals when at distance from the dog, but they must be short and used simultaneously. After the last down command, the handler returns to the dog and commands it to sit.

#### **Directions:**

Emphasis should be on the speed at which positions are changed, the clearness of the positions and how well the positions are held and how much the dog moves. To get any points, the dog should not move in total more than one body lengths from the starting point (in any direction). All movements are summed (back and forth, sideways, etc.). If the dog misses one position of the four e.g. takes a wrong position or has had a third command on a position, no more than 7 points should be given and if the dog misses two positions the exercise is failed (0 points).

If the dog sits up before the handler returns, no more than 8 points should be given. Extensive use of voice and exaggerated or long-lasting hand signals drop points. (See general rules.)

A third command on a position may be given, but this position is lost. The first time a second command has to be given on a position -2 points are reduced. The next additional ones are -1 point.

### **EXERCISE 1.9**

### **Recall with jumping over a hurdle**

**[Coeff . 3]**

#### **Commands:**

“Stay”, “Come or jump”, (“Heel”)

#### **Performance:**

The handler is placed in front of a hurdle at a distance of approximately 2 - 4 m from the hurdle (handler's choice) with the dog sitting in heel position. The steward announces the start of the exercise and commands the handler to leave the dog sitting in front of the hurdle. The handler walks around the hurdle to the other side (approximately 2 - 4 m) and recalls the dog to jump on the steward's permission. The dog should jump and take the heel position. The steward announces the end of the exercise. The height of the hurdle should be approximately the height of the dog at the withers. The height can be rounded off downwards rather than upwards. The maximum height, however, is 50 cm.



**Directions:** Emphasis should be on the dog's willingness to follow the commands and recall, the dog's tempo and taking the shortest way to the handler. If the dog touches the hurdle even slightly when jumping, the no more than 8 points can be awarded. If the dog supports itself on the hurdle, if the hurdle is turned over or if the dog doesn't jump, the exercise is failed.

**EXERCISE 1.10**      **Send away around a cone and return**      **[Coeff. 3]**

**Command:** "Around" ["Right/left" and/or hand signal] ("Heel")

**Performance:** Handler stands with the dog in heel position at the starting point facing a cone, approximately 15-40 cm high, at a distance of approximately 10 m. The handler sends his dog from the starting point to run around the cone. The dog should run around the cone and return to the handler and take the heel position.

**Directions:** Emphasis should be on the dog's willingness to follow the commands, the dog's tempo and its taking the shortest way. When running around the cone, its distance from the cone should be reasonable taking into account the breed and tempo. The dog's path can be clockwise or counterclockwise around the cone. If a recall command is given, no more than 8 points can be awarded. If the dog turns having reached the cone, but not gone around it, no more than 5 points can be awarded. The exercise is failed (0 points.), if the dog turns before it has reached the cone, if a third "around" command is given or if a second recall command is given. If the dog has to be redirected, handsignals may be combined to the directing command. The breed should be taken into consideration in judging the tempo.

Showing the dog directions or touching the dog at the starting point will lead to failing of the exercise.

**EXERCISE 1.11**      **General impression**      **[Coeff. 2]**

**Directions:** When judging the general impression the dog's willingness to work and obey the commands are essential. Accuracy and precision are important, as well as natural movements of both the handler and the dog. To get a high score both the handler and the dog must work well as a team, show mutual enjoyment in working together and good sportsmanship. The activities during and between the exercises influence the score for the general impression.

If the dog leaves the ring or if it relieves itself in the ring, no points can be awarded for the general impression. If the dog is out of control and leaves the handler during or between the exercises (even once), but stays in the ring, no more than 5 points can be awarded.

## CLASS 2

### EXERCISE 2.1

#### **Lying in a group for 2 minutes. Handlers out of sight**

**[Coeff. 2]**

**Commands:**

“Down”, “Stay”, “Sit”

**Performance:**

The exercise starts when all handlers of the group stand in a row at an approximately 3 meters distance from each other with their dogs in heel position and the steward announces “Exercise starts”. The exercise ends when the handlers have returned to their dogs and all dogs have taken their heel position and the steward has announced “Exercise over”.

The lying down on command from the heel position is performed one by one. The dogs should be commanded to lie down from left to right and to sit up from right to left so that the first to lie down is the last to sit up. The steward tells when to give the command. The handlers walk out of sight of the dogs together and stay hidden for 2 minutes. The two-minute period starts when all the handlers are out of sight. The dogs stay lying down and are subjected to distractions, for example a person weaving between the dogs. When 2 minutes have elapsed, the handlers are instructed to walk together back into the ring and line up inside the ring. The handlers are then told to walk up behind their dogs, passing them at a distance of approximately 0,5 m and to stop approx. 3 metres behind their dogs and to turn around. The handlers are then instructed to walk up beside their dog and told, one by one, to command their dog to heel position.

The handlers should be reminded that they are not to give their commands too loudly. This might influence the other dogs and will result in a strong reduction of points. There should be at least three dogs in a group but no more than six.

**Directions:**

A dog that fails to lie down (two commands), stands up or sits while the handlers are out of sight, or crawls more than its own body length or lies on its back, fails the exercise (0 points). If the dog sits or stands up after the two-minute period is over but the handlers have already lined up inside the ring, no more than 5 points can be awarded. If the dog moves as well, the exercise is failed (0 points).

All movement should clearly reduce points. If the dog barks 1-2 times, 1-2 points are deducted; if it barks most of the time, the exercise is failed (0 points). Restlessness, such as shifting weight from one side to another, results in a reduction of points. The dog is allowed to turn its head and look around, and it is allowed to show interest if there is distraction or noise inside or outside the ring. This must not, however, give an appearance of restlessness or anxiety, If a dog stands up and goes close to another dog, so that there is fear for severe disturbance or a fight, the exercise must be stopped and then resumed for all dogs except the dog that caused the disturbance.

If the dog reacts (lies down or sits up) before the handler's command (e.g. on a neighbour's "down" or "sit" command), no more than 8 points can be awarded. If the dog has reacted too early (lying down or sitting up), it should remain in this position (lying down or sitting up). Failing to do so at the beginning of the exercise leads to failing the exercise. If the dog sits up independently and lies down again, no more than 5 points can be awarded.

No more than 7 points can be awarded if a dog lies on its side (flank) or fails to sit up.

## **EXERCISE 2.2**

### **Heelwork**

**[Coeff . 3]**

#### **Command:**

"Heel"

#### **Performance:**

Heelwork is tested at different speeds, normal, slow and fast pace, in conjunction with turns and turnabouts and halts. The dog must also be tested when the handler moves two or three steps forwards and backwards as well as a short distance of walking (5-8) directly backwards. *The general directions describe heelwork in more detail.*

It should be made sure that that path for walking backwards is even and safe.

All dogs in one test or competition should do the heelwork according to the same scheme.

#### **Directions:**

A dog that leaves the handler or follows the handler at a distance of more than half a meter during a major part of the exercise, fails the exercise (0 points). If the dog moves slowly, no more than 6-7 points should be awarded. Lack of contact and extra commands are mistakes. An imperfect direction (not parallel) of the heel position should result in a loss of about 2 points. Slowing down and stopping before, during or after turns will reduce points. Points should be reduced if a dog walks very near to the handler so that it disturbs or hinders the handler, even more points should be dropped if the dog leans or touches the handler. Slight carefullness of the handler is allowed when walking backwards. Not more than 1-2 points should be dropped if the walking backwards are is not quite perfect.

## **EXERCISE 2.3**

### **Stand and/or sit and/or down under march**

**[Coeff. 3]**

#### **Commands:**

"Heel" (3 times), "Stand", "Sit", "Down"

#### **Performance:**

The exercise is performed according to the enclosed figure. The dog takes two out of the three positions stand/sit/down. The judge will decide before the competition which two positions will be used and in which order.

Under march the handler commands, on instruction of the steward, the dog to take the first position (stand/sit/down) and then to take the second position. The pace should be normal pace. There should be a turn left or a turn right, the turning direction being the same for all competitors. The turning points (left/right, 90°) should be marked with small cones. The order of the positions and the order of turning left and right may vary, but should be the same for all dogs in a competition.

The steward will instruct the handler when to start, when to command the dog to stand/sit/down, when to turn around and when to stop at the end. The turns at the corners are done independently. The stops will be approximately at the middle (5 m) of the 10 meter line segment. The handler continues to walk 5 m (approximately to the next turning point), turns around on command of the steward, continues to walk towards his dog, passes his dog at a distance of approx. 0,5 m leaving the dog to his left, continues to walk for approx. 2 m, turns around on command of the steward and walks up towards his dog. Upon reaching his dog, the handler gives the heel command without stopping. They continue to the turning point (5 m), turn left/right, and continue along the next segment line to the middle of the next segment line. The exercise continues similarly as the first phase of the exercise. The exercise ends when the steward has given a stop command and announced "End of exercise".

The stand, sit and down positions should be parallel to the imaginary lines connecting the starting/turning/ending points. The distance between the dog and the turning points should be approx. 0,5 m taking into consideration the size of the dog. The corners should be 90°, not rounded off. The handler and dog should pass the corner cones from the right side leaving them on the left side. See figure for ex. 3 of class 2.

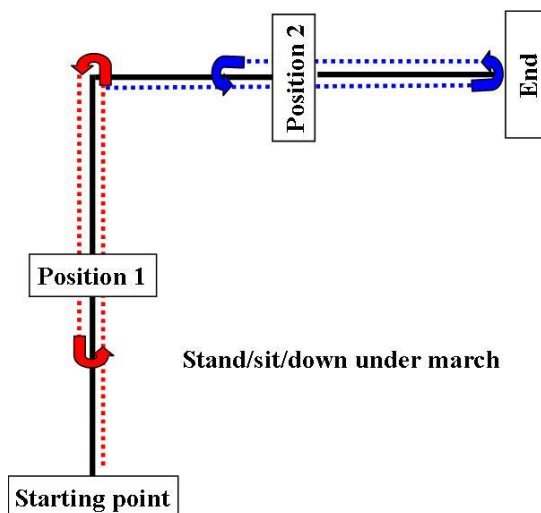
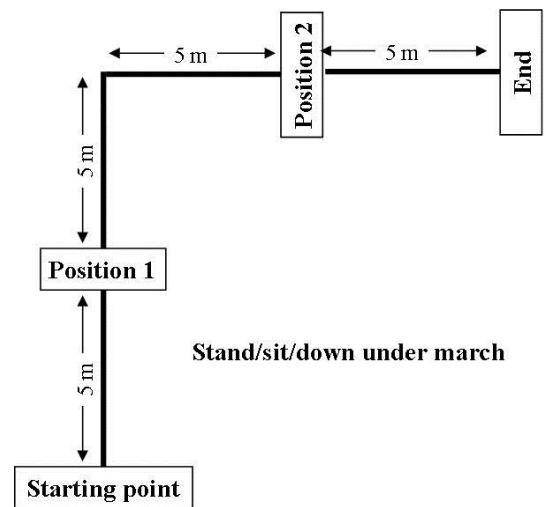

**Directions:**

To get points for the exercise, at least one position must be performed. If the dog stops once in a wrong position (e.g. sitting instead of down), or if the dog misses one position, no more than 7 points can be awarded for the exercise. The dog misses the position if it takes the wrong position, if it moves more than one body length after the command, if the handler gives a second command or if strong hand signals or strong body language are used on the position.

If the dog completely fails to stop at a position, i.e. has not stopped before the handler has turned around, the exercise is failed (0 points). A second command can be used to stop the dog and if the dog stops before the handler has reached the next turning point, the exercise can be continued, but no more than 6 points can be awarded.

In judging, attention should be paid to the heelwork as well as to the positions (stand/sit/down) being parallel to the imaginary lines connecting the starting/turning/ending points.

Moving, standing/sitting/lying down slowly, not taking straight positions, bad heelwork, changing pace, rounded corners and not keeping the correct course (parallel to the imaginary connecting lines), and turning to look at the dog are mistakes. The reduction for such mistakes should be 1-4 points. If the handler passes the dog from the wrong side 1 point should be reduced.

No extra commands are allowed on the positions. Hand signals and body language on the stand/sit/down commands are grave mistakes, and will severely reduce points. Depending on their strength and duration the reduction is 3-5 points or they can fail the position.

**EXERCISE 2.4**

**Recall with stand**

**[Coeff. 4]**

**Commands:**

“Down”, (“Stay”) “Come” “Stand” OR hand signal, “Come” (“Heel”)  
[Hand signals: one hand or both hands can be used]  
The handler should inform the judge whether he/she uses a voice command or a hand signal.

**Performance:**

The dog is commanded to lie down and the handler walks approx. 25 – 30 m in the indicated direction and turns around to face the dog. On permission from the steward, the handler recalls the dog. The handler orders the dog to stand when the dog has covered approximately half of the distance. When told, (after approximately 3 seconds) the handler recalls the dog again to heel position. The steward tells the handler only when to recall the dog. The handler gives the stop command independently at the marker. A verbal stop command or a hand signal is allowed. The dog’s name may be combined with the recall commands, but name and command must be well combined together and may not give the impression of two separate commands.

**Directions:**

It is important that the dog responds willingly to all recall commands. The dog should move at good speed and keep its pace, at least a fast trot. Slow movement is a mistake. The breed should be taken into consideration in judging the speed. The dog should begin stopping at once after the command. When evaluating the stop, the speed of the dog should also be considered. There can be a slight tolerance on immediate stopping for fast dogs, but not for slow dogs. To get full points (for the stop) no more than one body length can be exceeded from the time of command to the stop. To obtain any points (for the stop) no more than 3 body lengths can be exceeded. If more than altogether 2 recall commands are given, the highest score is 7. A third recall at a position results in failure of the exercise as well as two recalls on both positions. If the dog misses the position (stops after 3 body lengths) no more than 7 points can be awarded. If there is no attempt to stop, the exercise is failed (0 points). If the dog stops in a wrong position no more than 7 points can be awarded. If the dog sits or stands up before the first recall command, no more than 8 points can be given. If the dog moves more than one body length before the first recall command, the exercise is failed (0 points).

**EXERCISE 2.5**

**Send away to a square down and recall**

**[Coeff. 4 ]**

**Commands:**

“Forward”, [“Right/left” and/or hand signal], (“Stand”), “Down”, “Come”.

**Performance:**

Before starting the exercise, that handler should inform the judge whether he/she will command the dog first to stand and then to lie down in the square or to lie down directly in the square.

When the steward gives permission, the handler directs the dog to a 3 m x 3 m square that is located approximately 23 metres from the starting point. The dog should move in a straight line to the square and should enter the square from the front.

When the dog reaches the square, the handler commands the dog either to stand and then to lie down or directly to lie down. If the dog is commanded to stand, the stand position should be clear and stable, before the down command is given.

When told, the handler walks forward in the direction of the right-side cone. When the handler has reached a distance of approximately 2 m from the cone the handler is told to turn left and after approximately 3 m the handler is told to turn left again, back towards to the starting point. After approximately 10 m from the second turn, the handler is told to recall the dog while continuing to walk towards the starting point. Having reached the starting point the handler is told to stop.

The handler should not use more than four commands during this exercise, the fourth command being a stand command in the square. Alternatively the handler can command the dog directly to lie down and thus use only three commands. If the dog has to be redirected, handsignals may be combined to the directing command.

The size of the square is 3 X 3 m. The distance between the middle of the square and the starting point is approximately 23 metres. Cones (approx. 10 - 15 cm high) mark the square at each corner. Visible lines (e.g., tape, chalk lines, strands) should connect the cones on their outer side. There should be at least an approx. 3-5 meters distance from the borders of the square to the nearest ring borders. See Figure for exercise 5 of class 2.

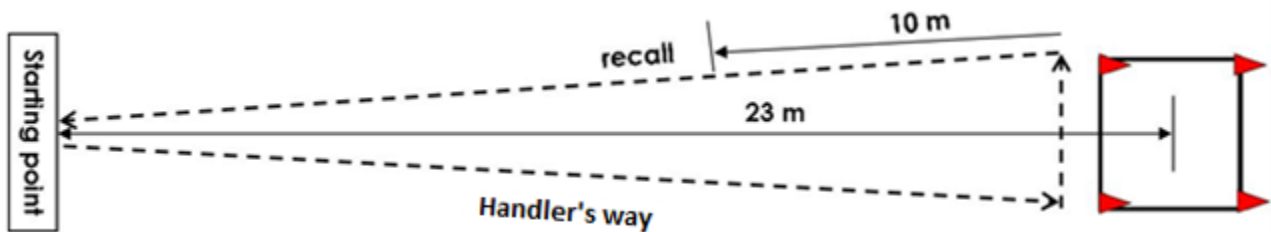

**Directions:**

The dog's willingness to follow directions and commands, the dog's tempo and straight route should be emphasised. To get 10 points, the handler should not use more than four commands during this exercise, the fourth command being the stand command in the square. The dog must follow the commands (e.g., if a stand command is given in the square it must stand and if it is commanded to lie down directly it must do so).

If the handler moves (takes steps in any direction) while giving the commands, the exercise is failed (0 points). If there is excess action (body language) from the handler, no more than 8 points should be given. If the dog acts on its own, this reduces points (i.e. if the dog stops or lies down without a command). If the dog lies down outside the square the exercise is failed. If the dog is already down, no redirecting command is allowed. To get points, no part of the dog may be outside the markings of the square, except for the tail.

The exercise is failed if the dog rises to sit or stand before the handler's second turn. No more than 5 points can be awarded if the dog rises (to sit or stand) after the handler's second turn before it is recalled. If the dog moves in the square without rising, no more than 7 points can be awarded. If it moves and crosses the border before recall, the exercise is failed. If the dog moves very slowly, no more than 6 points should be given.

A second recall, stand or down command reduces 2 points/command. The exercise is failed if even one of these commands has to be given a third time. Hand signals are only allowed if the dog has to be directed. A hand signal given when the dog is beside the handler reduces 2 points.

If the dog takes the wrong position in the square 3 points are reduced and if the standing position is not clear 2 points are reduced. The reduction of points for extra directing commands depends on their strength and the dog's willingness to obey the commands, thus the reduction can be 1-2 points.

Showing the dog directions (e.g. the square) or touching the dog at the starting point will lead to failing the exercise.

## **EXERCISE 2.6**

### **Directed retrieve**

**[Coeff. 3]**

#### **Commands:**

“Heel”, “Stand”, “Right/left” and/or hand signal, “Retrieve”, “Release” (“Heel”)

#### **Performance:**

Handler and dog stand at the starting point facing a marker at a distance of approximately 5 m. The marker is situated approximately 10 m from the centre of the imaginary line between two dumbbells, and the starting point is approximately 15 m from this line. The steward places two wooden dumbbells in a row approx. 10 m apart from each other so that they are easily seen. The dumbbell that is drawn (left or right) is set down first.

The handler is told to walk with his dog from the starting point towards the marker, pass the marker (1-2 m) and turn around on the command of the steward after which he/she should place the dog (independently) in a standing position at the marker facing the starting point. The handler leaves the dog and returns to the starting point and turns towards the dumbbells. The handler should not stop when leaving his dog. After about 3 seconds, the handler is told to direct the dog to the correct dumbbell that has been determined by draw, and the dog should retrieve and deliver the dumbbell correctly. The directing command (right/left) and the retrieve command should be given close together, thus a late retrieve command will be interpreted as a second command. See figure for ex. 6 of class 2.

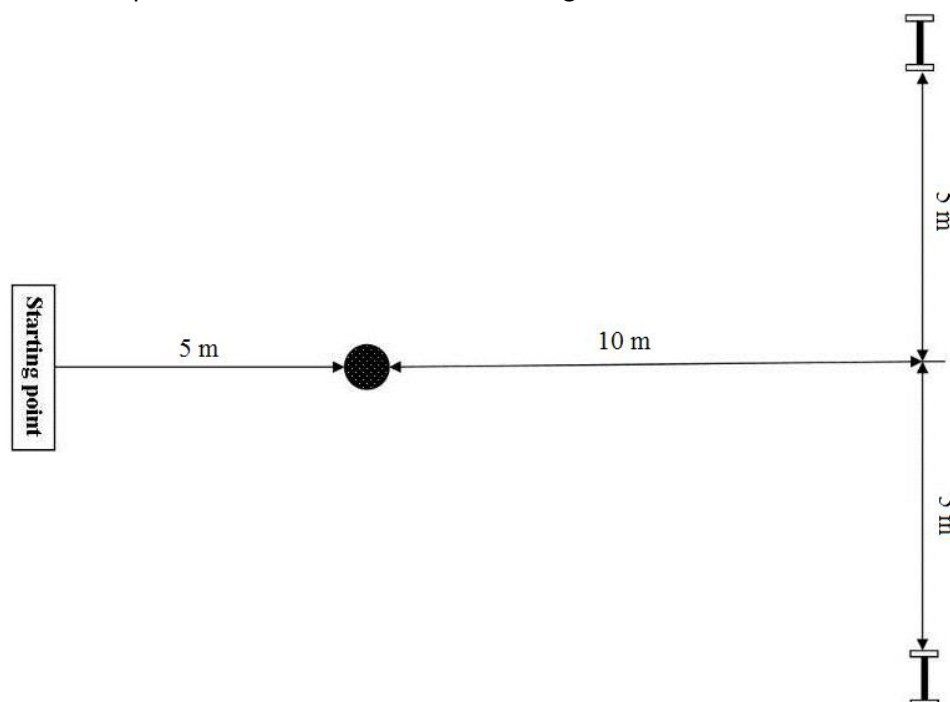



**Directions:**

Emphasis should be on the dog's willingness to follow the retrieve/directive commands, the dog's tempo and its taking the shortest way to the correct dumbbell. Showing the dog directions or touching the dog at the starting point will lead to failing of the exercise (0 points). To obtain points for this exercise, the dog should remain standing at the marker until commanded forward. A dog that lies down, sits or moves at the marker, cannot get more than 8 points. If the dog moves more than one body length from its standing position before command the exercise is failed (0 points).

If the dog goes to the wrong dumbbell, is stopped and redirected to the correct one and the dog brings the correct one, 3 points should be reduced. If the dog is redirected from the wrong dumbbell without a stop, 2 points should be reduced. If the wrong dumbbell is picked up the exercise is failed (0 points).

The reduction for extra directing /redirecting commands depends on their strength and the dog's willingness to obey the commands. It can be 1-2 points/command.

*For dropping the dumbbell and for chewing or biting on the dumbbell see the general guidelines for judging exercises.*

**EXERCISE 2.7**

**Scent discrimination and retrieve**

**[Coeff. 4]**

**Commands:**

“Seek”, “Release”, (“Heel”)

**Performance:**

The handler stands at the starting point with the dog in heel position and the steward announces the start of the exercise and gives the handler a wooden retrieve object (10 cm x 2 cm x 2 cm), which has been marked beforehand with some identification. The handler can keep the object in his/her hand for approximately 10 seconds. The dog is not allowed to touch or scent the object at this stage. The steward tells the handler to hand over the object and to turn around. The handler decides whether the dog does or does not see when the objects are positioned. Heel and stay commands are allowed. The steward walks to place the handler's object, without touching it, together with five other similar objects on the ground or floor at a distance of about 10 meters from the handler. The steward places the other five objects by hand and thus touches them. The objects are placed in a circle or horizontal line at a distance of approximately 25 cm from each other. The objects should be placed in the same pattern for all competitors, but the position of the handler's object may vary. In case of a horizontal line the handler's object should not be the outermost object in either end of the line.

The handler is then told to turn around and to command the dog to retrieve the marked object. The dog should find the handler's object, retrieve it and deliver it to the handler in accordance with the general directions.

The dog should be allowed to work approximately half a minute if the working is active and goal driven. There should be six new objects for each competitor.

**Directions:**

Emphasis should be on the dog's willingness to work and its tempo. If the dog picks up the wrong object once but then brings the correct one, no more than 7 points can be awarded. The exercise is failed (0 points), if the dog is allowed to scent or touch the object in the beginning of the exercise before it is handed back to the steward, if commands are given when the dog is at the objects, or if the dog picks up a wrong object twice. Failure is not caused if the dog scents the objects when seeking for the correct one.

*For dropping the dumbbell and for chewing or biting on the dumbbell see the general guidelines for judging exercises.*

**EXERCISE 2.8**

**Distance control**

**[Coeff. 4]**

**Commands:**

"Down" "Stay", "Sit", "Stand", "Down" and /or hand signals.

**Performance:**

The dog should change positions 6 times (sit / stand / down) according to the handler's commands and remain in its original place. A boundary is formed in back of the dog by an imaginary line connecting two markers. The handler commands his/her dog to lie down at the starting point in front of the boundary. The handler leaves the dog and moves to an assigned place approx. 10 m from the dog and turns around. The order of taking the positions should always be sit - stand - down or stand - sit - down and thus the last command for changing position should be "down". The order of taking the positions should be the same for all competitors.

The steward shows the handler in which order the dog should change positions with written signs or drawings or an electric display board. The steward should stand approximately 3-5 m from the dog and so that he/she is not able to see the dog when displaying the instructions. The steward should change the sign about every 3 seconds.

The handler may use both voice commands and hand signals when at distance from the dog, but they must be short and used simultaneously. After the last down command, the handler returns to the dog and commands it to sit.

**Directions:**

Emphasis should be on the speed at which positions are changed, the clearness of the positions and how well the positions are held and how much the dog moves. To get any points, the dog should not move in total more than one body length from the starting point (in any direction). All movements are summed (back and forth, sideways, etc.). If the dog misses one position of the six, no more than 7 points should be awarded and if it misses two positions no more than 5 points should be awarded. Thus if the dog jumps over one position and takes the next position instead, no more than 5 points can be awarded. If the dog moves one body length it cannot score more than 5. The dog has to change position at least four times on command to get points.

If the dog sits up before the handler returns, no more than 8 points should be given. Extensive use of voice and exaggerated or long-lasting hand signals drop points. (See general rules.)

No more than 8 points can be achieved if the dog has to have two commands on a position change. Disobeying a second command on a position leads to missing this position. The first extra command on a position is -2 points but the next ones are -1 point.

It is possible to get points for this exercise even if 3 – 4 of the positions have been achieved only after an extra command, if the extra commands are obeyed immediately, and lead to good, clear positions and the exercise is otherwise excellent.

## **EXERCISE 2.9**      **Jumping over a hurdle and retrieving a metal dumbbell**      **[Coeff. 3]**

**Command:**      “Jump”, “Retrieve” and “Release” (“Heel”)

**Performance:**      The handler is placed in front of a hurdle at a distance of approximately 2 - 4 m from the hurdle (handler’s choice) with the dog sitting in heel position. The steward hands over the dumbbell to the handler. The handler throws the metal dumbbell over the hurdle. The handler commands the dog to jump over the hurdle, retrieve the dumbbell and jump back. The “retrieve” command should not be given later than when the dog starts his jump.

**Directions:**      The exercise begins in heel position and ends in heel position when the dog has released the dumbbell and the steward has announced “Exercise over”. If the dog has to search for the dumbbell for a moment and is working actively, no points should be reduced. If the dog touches the hurdle even slightly when jumping, the maximum score is 8 points. If the dog supports itself on the hurdle or if it does not jump both back and forth, the exercise is failed (0 points). If the hurdle falls over, the exercise is failed (0 points). If the dog anticipates the command, 2-4 points should be reduced. A second “retrieve” or “jump” command reduces 2 points. If the dog leaves as the dumbbell is thrown, the exercise is failed.

*For dropping the dumbbell and for chewing or biting on the dumbbell see the general guidelines for judging exercises.*

## **EXERCISE 2.10**      **General impression**      **[Coeff. 2]**

**Directions:**      When judging the general impression the dog’s willingness to work and obey the commands are essential. Accuracy and precision are important, as well as natural movements of both the handler and the dog. To get a high score both the handler and the dog must work well as a team, show mutual enjoyment in working together and good sportsmanship. The activities during and between the exercises influence the score for the general impression.

If the dog is out of control and leaves the handler during or between the exercises, but stays in the ring, no points can be awarded for the general impression. If the dog relieves itself in the ring, the dog is disqualified.

## CLASS 3

### EXERCISE 3.1

**Sitting in a group for 2 minutes,  
handlers out of sight**

**[Coeff. 2]**

### EXERCISE 3.2

**Lying down for 1 minute and recall**

**[Coeff. 2]**

#### Commands:

“Sit”, “Stay”, “Down” and/or Hand signal , “Come”

#### Performance:

The exercises 1 and 2 are combined.

Ex. 3.1/ Part 1: Sitting in a group for 2 minutes

Ex. 3.2/ Part 2: Lying on a group for 1 minute and recall

The points are given for both parts separately after the end of the second part of the exercise.

The exercise starts when all handlers of the group stand in a row at approximately 4-5 meters distance from each other with their dogs in heel position and the steward announces “Exercise starts”. The exercise ends (Part 1) when the handlers have returned inside the ring, facing their dogs at a distance of not less than approximately 10 meters and the steward announces “Exercise over”. Part 2 (Ex. 2) starts immediately after part 1.

The dogs are sitting in heel position in a row at approx. 4 - 5 meters distance from each other. When told, the handlers leave their dogs and walk out of sight of the dogs and stay hidden for 2 minutes. The two-minute period starts when all handlers are out of sight. When 2 minutes have elapsed, the handlers are instructed to walk back into the ring and take a standing position inside the ring. The handlers are then told to walk and take a standing position approximately 10 meters from the dogs facing the dogs.

Part 1 has ended and part 2 begins immediately.

The steward starts the second part of the exercise “Part 2 begins”. The dogs should be sitting.

Handlers of dogs that have taken a wrong position during part 1 should command their dogs to the correct position, i.e. sit, on permission of the steward.

The handlers are told to command the dogs down one by one from left to right. They will be lying for 1 minute and after which they will be recalled one by one from right to left. The recall will be on the steward’s command and the steward will move to the next dog only after the previous dog is in heel position beside the handler.

Loud commands may disturb the others and will severely reduce points.

There should not be more than four dogs in a group, but no less than three. In case of only five entries in class 3, all five can do the exercise together.

It is up to the judge to decide how handlers with dogs that have failed part 2 from the start and handlers that do not wish to recall their dogs should do.

**Directions:**

A dog that stands up or lies down during part 1 gets 0 points for part 1. A dog that leaves its place (more than one body length) fails the whole exercise (parts 1 and 2). If a dog lies down or stands up after the two-minute period is over and the handlers have already lined up inside the ring, no more than 5 points can be awarded.

Dogs that are standing or lying after part 1 has ended can be commanded one by one to a sitting position. No points will be lost for the first command to a sitting position. If a second command is needed, 2 points will be reduced. Part 2 is failed (0 points) if the dog does not sit.

If a dog changes position after part 2 has started i.e. from sit to stand or lying down the handler is not allowed to correct the position anymore. A dog that is already lying down when the phase begins where the dogs are commanded to lie down cannot be awarded more than 7 and a dog that is standing cannot be awarded more than 8.

If a dog lies down before command (i.e. on a neighbour's command) no more than 8 points can be awarded for part 2.

Part 2 is failed if the dog does not lie down, if the dog changes position (to sit or stand) during the one-minute period, moves more than one body length or lies on its back. Not more than 7 can be awarded if the dog lies on its side.

If a dog comes on another dog's recall command, no more than 5 points can be awarded for part 2. A dog coming without any recall command will fail part 2 (0 points). If a dog needs a second recall command, not more than 7 can be awarded.

If the dog barks 1-2 times, 1-2 points are reduced; if it barks most of the time, the exercise is failed (0 points).

All excess movement should reduce points. Restlessness, such as shifting weight from one side to another, should reduce points. The dog is allowed to turn its head and look around, and it is allowed to show interest if there is distraction or noise inside or outside the ring. This, however, should not give an appearance of restlessness or anxiety. If a dog stands up and goes close to another dog, so that there is fear for severe disturbance or a fight, the exercise must be stopped and then resumed for all the dogs except for the dog that caused the disturbance.

Exercises 3.1 - 3.2 are perceived as one exercise and thus there is not a possibility for the handler to intervene (rewarding or communicating) in any way between these two exercises.

It is recommended that the area outside the ring in front of the dogs is a closed area (no outsiders besides personnel are allowed) during this exercise. In the SW and WW competitions this arrangement is obligatory.

### **EXERCISE 3.3**

### **Heelwork**

**[Coeff. 3]**

**Command:**

“Heel”

**Performance:**

Heelwork is tested at different speeds, normal, slow and fast pace, in conjunction with turns, turnabouts and halts. The dog must also be tested when the handler moves two or three steps in different directions from standing position, and when the handler makes turns and turnabouts from the standing position. The dog must also be tested in walking backwards approximately 5 - 10 meters (15-30 steps). The steward tells when to start and when to stop. Walking backwards can include one turn. It should be made sure that the path for walking backwards is even and safe. The steward should have some landmarks so that the distance of walking backwards can be correctly estimated.

*The general directions describe heelwork in more detail.*

All dogs in one test or competition should do the heelwork according to the same scheme.

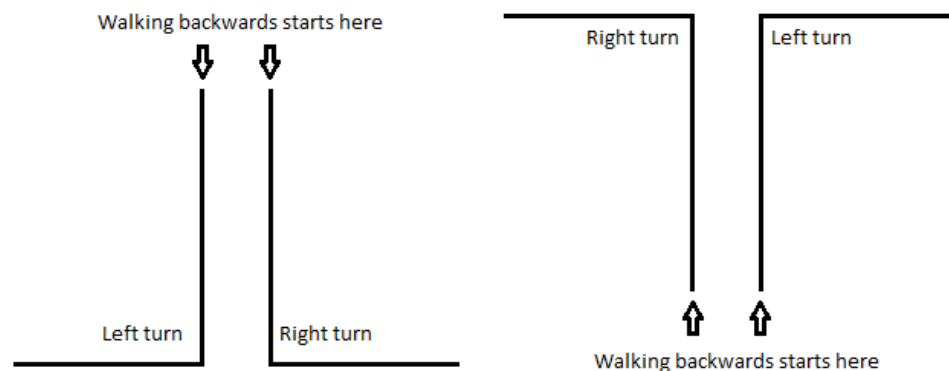

**Directions:**

A dog that leaves the handler or follows the handler at a distance of more than half a meter during a major part of the exercise fails the exercise (0 points). If the dog moves slowly, only 6-7 points should be awarded. Lack of contact and extra commands are mistakes. An imperfect direction (not parallel) of the heel position should result in loss of about 2 points. Slowing down and stopping before, during or after turns will reduce points. Points should be reduced if a dog walks very near to the handler so that it disturbs or hinders the handler, even more if the dog leans and touches the handler. Slight carefullness of the handler is allowed when walking backwards. Not more than 1-2 points should be dropped if the heelwork during walking backwards is not quite perfect.

### EXERCISE 3.4

### Stand, sit and down under march

[Coeff. 3]

#### Commands:

“Heel”, “Stand”, “Sit”, “Down”,

#### Performance:

The exercise is performed according to the enclosed figure. The judge will decide before the competition in which order the positions should be done. Under the march the handler commands, on instruction of the steward, the dog to take the standing, sitting and down position. The pace should be normal pace. There should be a left turn and a right turn. The turning points (left/right, 90°) should be marked with small cones or signs. The order of the positions and the order of turning left and right may vary, but should be the same for all dogs in a competition.

The steward will instruct the handler when to start, when to command the dog to stand/sit/lie down, when to turn around and when to stop at the end. The stops will be approximately at the middle (5 m) of the 10 meter line segment. The handler continues to walk 5 m (approximately to the next turning point), turns around on command of the steward, continues to walk towards his dog, passes his dog at a distance of approx. 0,5 m leaving the dog to his left, continues to walk for approx. 2 m, turns around on command of the steward and walks up towards his dog. Upon reaching his dog, the handler gives the heel command without stopping. They continue to the next turning point (5 m), turn left/right, and continue along the next segment line to the middle of the next segment line. The exercise

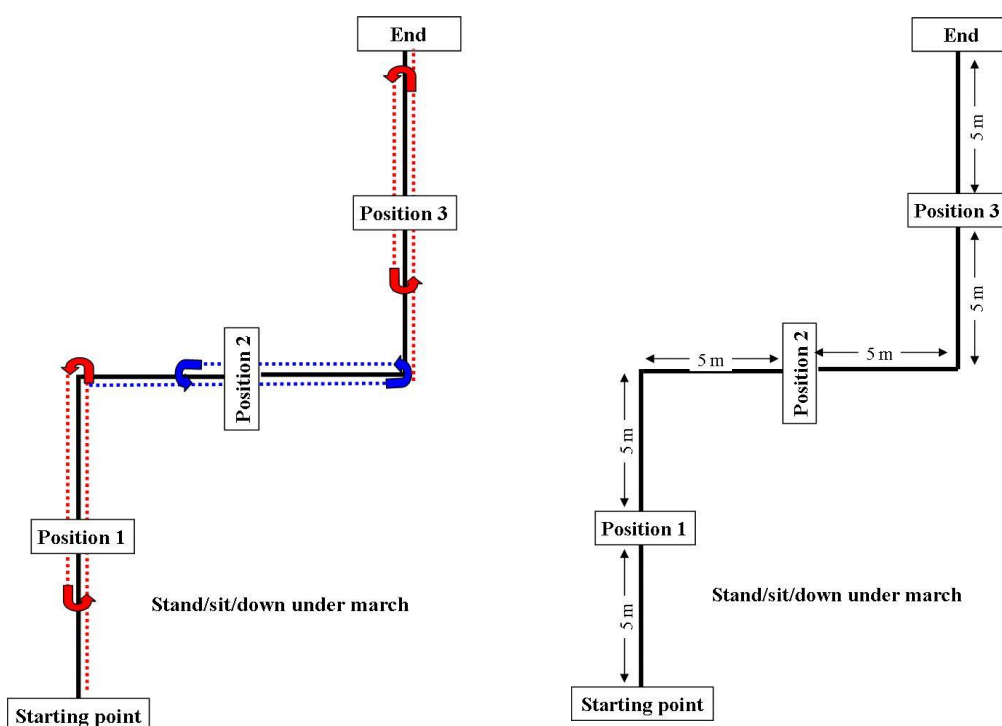

continues similarly as the first phase of the exercise. The exercise ends when the steward has given a stop command and announced “end of exercise”. The stand, sit and down positions should be parallel to the imaginary lines connecting the starting/turning/ending points. The distance between the dog and the turning points should be approx. 0,5 m taking into consideration the size of the dog. The corners should be 90°, not rounded off. The handler and the dog should pass the corner cones from the right side leaving them on the left side. See figure for ex. 4 of class 3.

**Directions:**

To get points for the exercise, at least two positions must be performed. If the dog stops once in a wrong position (e.g. sitting instead of down), or if the dog misses one position, no more than 7 points can be awarded for the exercise. The dog misses a position if it takes the wrong position, if it moves more than one body length after the command, or if the handler gives a second command or if strong hand signals or strong body language are used on the position.

If the dog completely fails to stop at a position, i.e. has not stopped before the handler has turned around, the exercise is failed (0 points). A second command can be used to stop the dog and if the dog stops before the handler has reached the next turning point, the exercise can be continued, but no more than 6 points can be awarded.

In judging, attention should be paid to the heelwork as well as the stand/ sit /down positions being parallel to the imaginary lines connecting the starting/turning/ending points. Moving, standing/sitting/lying down slowly, not taking straight positions, bad heelwork, changing pace, rounded corners and not keeping the correct course (parallel to the imaginary connecting lines), and turning to look at the dog are mistakes. The reduction for such mistakes should be 1-4 points.

No extra commands are allowed on the positions. Hand signals and body language on the stand/sit/down commands are grave mistakes, and will severely reduce points. Depending on their strength and duration the reduction is 3-5 points or they can fail the position.

**EXERCISE 3.5**

**Recall with stand and down**

**[Coeff. 4]**

**Commands:**

“Down”, “Stay”, “Come” (3 times), “Stand”, “Down” OR hand signals.

[Hand signals: one hand or both hands can be used]

**Performance:**

The dog is placed in a down position and the handler walks approx. 30 – 35 m in the indicated direction. On permission from the steward, the handler recalls the dog. The handler orders the dog to stand when the dog has covered approx. one third of the distance. When told, the handler recalls the dog again. Having covered approx. two thirds of the distance, the dog is ordered to lie down. After the second stop and on permission from the steward, the handler calls the dog to heel position. The steward tells the handler only when to recall the dog. The handler gives the stop commands independently at the markers (cones). Oral commands and hand signals may be mixed so that an oral command may be used at one position and a hand signal at another, but not simultaneously. The dog’s name may be combined with the recall commands, but the name and the command must be well combined together and may not give the impression of two separate commands.



**Directions:**

It is important that the dog responds willingly to all recall commands. The dog should move at a good speed and keep its pace, at least a fast trot. Slow movement is a mistake. The breed should be taken into consideration in judging the speed. The dog should begin its stop at once after the  $\varnothing$  command. When evaluating the stop, the speed of the dog should also be taken into consideration. There can be a slight tolerance on the actual stopping for fast dogs, but not for slow dogs. To get full points (for a stop) no more than one body length can be exceeded from the time of command to the stop. To obtain any points (for a stop) not more than approximately 3 body lengths can be exceeded. If more than 3 recall commands are given, no more than 7 points can be awarded. A third recall on a single position results in failure of the exercise.

If the dog misses one position (i.e., does not stop within the limit of approximately three body lengths) no more than 6 points can be awarded. If there is no attempt to stop at one of the positions, no more than 5 points can be awarded. If the dog fails to stop at both positions, or takes the positions in an opposite order, the exercise is failed (0 points). If the dog stops once in a wrong position not more than 7 points can be awarded. If a dog changes a position 2 points should be reduced. If the dog sits or stands up before the first recall command, or moves less than one body length, no more than 8 points can be awarded. If the dog moves more than one body length before the first recall command, the exercise is failed (0 points).

**EXERCISE 3.6**

**Send away with directions, down and recall**

**[Coeff. 4]**

**Commands:**

“Forward”, “Stand”, “Right/left” and/or hand signal, (“Stand”), “Down”, “Come”.

**Performance:**

Before starting the exercise, the handler should inform the judge whether he/she will command the dog first to stand and then to lie down in the square or lie down directly in the square. The handler sends the dog to a circle and commands it to stand inside the circle. The dog should stand in the circle so that all four feet are inside the circle. The circle is 2 m in radius and its centre is approximately 10 m from the starting point. The centre of the circle can be pointed out by a very small marker (not a cone), but this is not necessary. The circumference of the circle should be made visible by marking it at least on 8 points (with short visible pieces of tape, chalk, etc.) or marking the whole circumference.

After the dog has stood approximately 3 seconds inside the circle, the handler is told to direct the dog to a 3 m x 3 m square at approximately 25 meters distance (middle of the square) from the starting point. The dog should move in a straight line to the square and should enter the square from the front.

The square borders, as well as the circumference of the circle, should be situated at least approx. 3 meters from the border of the ring. Cones (appr. 10 - 15 cm high) mark the square at each corner. Visible lines (e.g., tape, chalk lines) should connect the cones on their outer side.

When the dog reaches the square, the handler commands the dog either to stand and then to lie down or directly to lie down. If the dog is commanded to stand, the stand position should be clear and stable, before the down command is given.

When told, the handler walks towards the dog. When the handler has reached a distance of approximately 2 m from the dog (the handler is not directed into the square, however), the handler is told to turn, and after approx. 10 m to turn again and walk towards the starting point. After another 10 m the handler is told to recall the dog while continuing to walk towards the starting point. Having reached the starting point, the handler is told to stop.

The dog should move in a straight line to the circle and to the square and should enter the square from the front. The angle between the connecting lines of the starting point and the centre of the circle, and between the centre of the circle and the middle of the square should be 90°. See figure for exercise 6 of class 3.

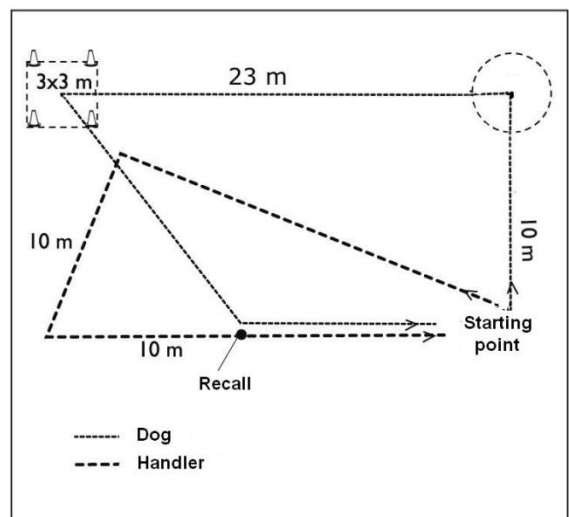
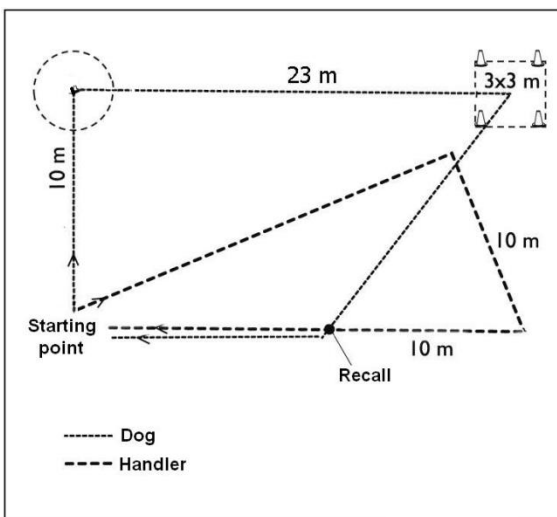
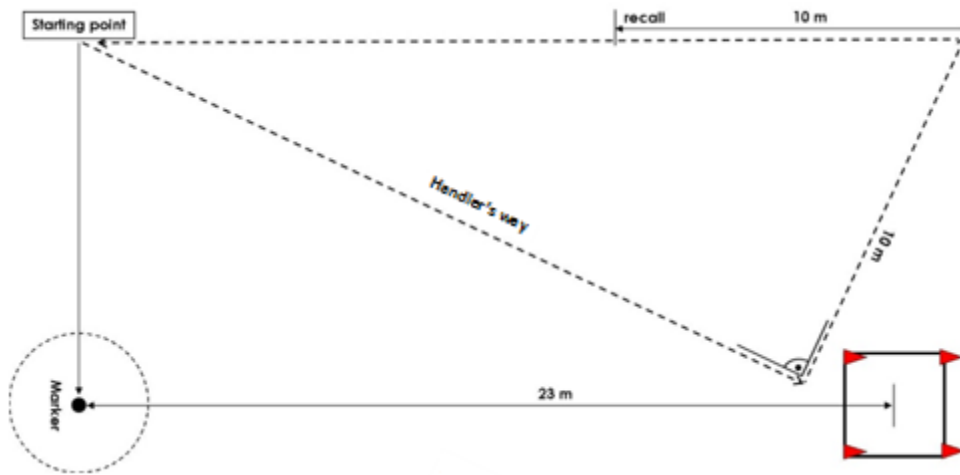

**Directions:**

The dog's willingness to follow directions and commands, the dog's tempo and straight routes should be emphasised. If the dog enters the square from the side or from the back ( $\frac{1}{2}$  - 1) points should be reduced. To get 10 points, the handler should not use more than 6 commands during this exercise, the sixth command being a stand command in the square. Another option is to use only the down command when the dog has entered the square and thus use only five commands. The dog must follow the commands e.g., if a stand command is given in the square, it must be obeyed and if a down command is given directly, the down should be immediate.

If the dog acts on its own, it reduces points. This means that for example the "stand" command in the circle and "stand" and "down" commands in the square have to be given. If the handler moves forward (takes steps in any direction) while giving the commands, the exercise has failed (0 points). If there is excess action (body language) from the handler, not more than 8 points should be given. The dog should have all four feet within the circle before the handler may direct the dog to the square. If the dog stands outside the circle, it should be redirected into the circle before the steward's command to continue (into the square). A dog that takes a sitting or down position in the circle should not be awarded more than 8 points. If the dog sits or lies down outside the circle or square, the exercise is failed (0 points). If the dog is already down, no redirecting command is allowed. To get points, the dog may not be outside the markings of the square, except for the tail.

The exercise is failed (0 points), if the dog rises to sit or stand before the handler's second turn. No more than 5 points can be awarded if the dog rises (to sit or stand) after the handler's second turn before it is recalled. If the dog moves in the square without rising, no more than 7 points can be awarded. If it moves and crosses the border before recall, the exercise is failed (0 points). If the dog moves very slowly, only about 6 points should be awarded.

A second recall, stand (both in the circle and in the square) or down command causes a reduction of - 2 points/command. The exercise is failed if even one of these commands has to be given a third time.

Hand signals are only allowed if the dog has to be directed. A hand signal given when the dog is beside the handler reduces points (-2 p).

The reduction for extra directing /redirecting commands depends on their strength and the dog's willingness to obey the commands. It can be 1-2 points/command.

If the dog takes the wrong position in the square, 3 points are reduced, and if the standing position is not clear 2 points are reduced. The reduction of points for extra directing commands depends on their strength and the dog's willingness to obey the commands, thus the reduction can be 1-2 points.

Showing the dog directions (e.g. the circle or square) or touching the dog at the starting point will lead to failing the exercise.

### **EXERCISE 3.7**

### **Directed retrieve**

**[Coeff. 3]**

**Command :**

“Forward”, “Stand”, “Right/left” and/or arm signal, “Retrieve”, “Release”

**Performance :**

Three wooden dumbbells are placed in a row approx. 5 m apart from each other so that they are easily seen. The starting point is approx. 20 m from the central dumbbell. The handler sends the dog to a circle and commands it to stand inside the circle. The dog should stand inside the circle so that all four feet are inside the circle. The circle is 2 m in radius and its centre is approximately 10 m from the starting point. The centre of the circle is pointed out by a small cone. The circumference of the circle should be made visible by marking it for example at least on 8 points (with short visible pieces of tape, chalk, etc.) or marking the whole circumference. After about 3 seconds, the handler is told to direct the dog to either the right or the left dumbbell, determined by draw, and the dog should retrieve and deliver it correctly. The directing command (right/left) and the retrieve commands should be given close together, thus a late retrieve command will be interpreted as a second command.

The steward places the three dumbbells after it has been determined by draw, which one is to be retrieved. The central dumbbell is never drawn. The dumbbell that is drawn (left or right) is always set down first. The dumbbells should be placed at least 3 m from the borders of the ring. During this procedure the handler and the dog stand at the starting point facing the central dumbbell at a distance of approx. 20 m. See figure for exercise 7 of class 3

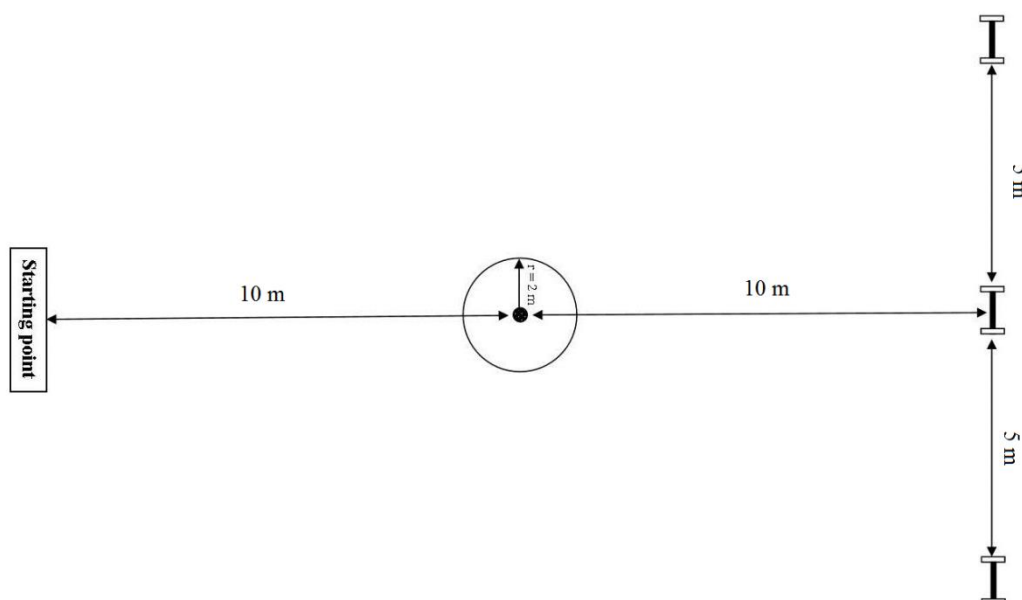

**Directions:**

Emphasis should be on the dog's willingness to follow the directive commands, the dog's tempo and its taking the shortest way to the correct dumbbell. To obtain points for this exercise, the dog should stand within the circle. A dog that lies down or sits at the cone cannot get more than 8 points.

The reduction for extra directing /redirecting commands depends on their strength and the dog's willingness to obey the commands. It can be 1-2 points/command.

If the dog goes to the wrong dumbbell, and is stopped and redirected to the correct one and the dog brings the correct one, 3 points should be reduced. If the dog is redirected from the wrong dumbbell without a stop, 2 points should be reduced.

If the dog picks up the wrong dumbbell, the exercise is failed (0 points).

*For dropping the dumbbell and for chewing or biting on the dumbbell see the general guidelines for judging exercises.*

### **EXERCISE 3.8**

### **Send around a cone, positions, retrieving and jumping a hurdle**

**[Coeff. 4]**

#### **Commands:**

"Around", "Stand/Sit/down" and/or hand signal – "right/left + retrieve" and/or hand signal – "Jump" – "Release", ("Heel")

#### **Description:**

Before the competition starts, the judge will determine which position (stand/sit/down) the dog should take on its way back to the handler. The position is the same for all competitors in the competition. The handler should draw the direction (right/left) from which the dog has to retrieve the dumbbell and jump the corresponding hurdle. Thus this determines if it will be the open hurdle or the closed one. The handler will not be told the direction at this stage. The handler will get the information when the dog has taken its position stand/sit/down. The dumbbells should always be placed in the same order (from right to left or from left to right) in a competition, regardless of which dumbbell should be brought.

An approximately 40 cm high, well visible cone is at a distance of approximately 20 meters from the starting point. Two hurdles (one closed with planks and one open) with a bar) are situated approximately 5 meters from the starting point and 5 meters from each other.

There should to be three different sizes of wooden dumbbells available, suitable for different breeds. The weight of the largest should be max 450 g. The size of the dumbbells should be in proportion of the size of the dog but the handler is free to choose the size.

**Performance:**

The handler stands with the dog in heel position at the starting point. The steward announces the start of the exercise and walks to place the dumbbells approximately 5 meters behind the hurdles. On instruction, the handler sends the dog to circle around the cone. When the dog has clearly passed around the cone and returned back towards the handler approximately 2 meters, but not passed the imaginary line connecting the dumbbells, the handler commands (independently) the dog to stop in the position that was determined by the judge. A voice command and a simultaneous hand signal may be given. After about 3 seconds, the steward informs the handler which direction was drawn and instructs the handler to command the dog to retrieve the correct dumbbell and jump the correct corresponding hurdle and return to heel position.

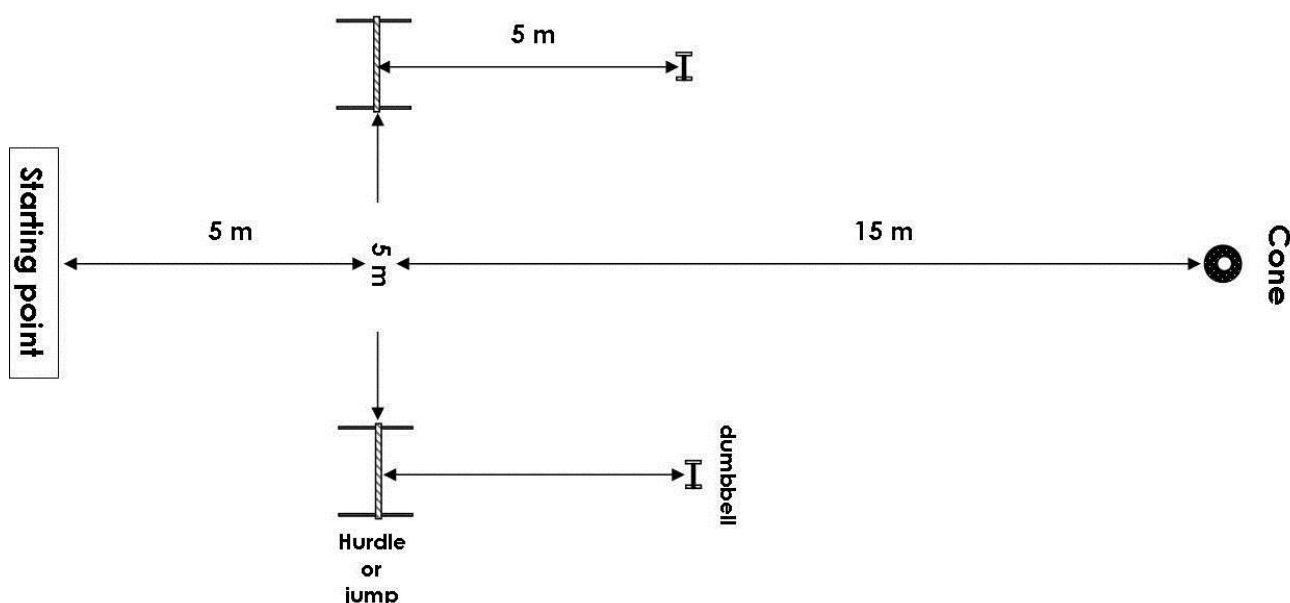

**Directions:**

Emphasis should be on the dog's willingness to follow the commands and directions, the dog's tempo and its taking the shortest ways. The dog has to show a good and consistent speed, at least a fast trot. Slow working will reduce points (1-5). The breed has to be taken into consideration when judging the speed. The dog should immediately obey the commands. There is a slight tolerance for fast dogs, but not for slow ones. To obtain points for this exercise, the dog must remain in its position (stand/sit/down) until it gets the command to go on with the exercise. A dog that takes the wrong position cannot get more than 8 points. If the dog turns back before the cone, it has to be redirected to the cone. This drops points. The exercise is failed (0 points) if the dog does not circle around the cone. The handler has two directing commands (-1 point for each additional command if the dog obeys). After the dog has gone around the cone the dog should take the correct position (stand/sit/down) on command.

The handler gets the information which dumbbell (right or left) must be retrieved when the dog has taken its position (stand/sit/down). The handler is allowed to give a jump command after the dog has picked up the dumbbell. If the dog passes the connecting lines of the dumbbells without having picked up the correct dumbbell, the exercise is failed (0 points).

If the dog goes to the wrong dumbbell (or hurdle), and is stopped and redirected (two commands) to the correct one and the dog brings the correct one, 3 points should be reduced. If the dog is redirected from the wrong dumbbell (or hurdle) hurdle without a stop, 2 points should be reduced.

The reduction of points for extra directing commands depends on their strength and the dog's willingness to obey the commands. It can be 1-2 points/command. The reduction of points for other extra commands should be congruent with the general directions.

If the dog jumps the hurdle on the way to the cone, the exercise is failed (0 points). If the dog picks up the wrong dumbbell or does not jump the hurdle or jumps the wrong hurdle, the exercise is failed (0 points).

If the dog touches the hurdle when jumping, 2 points should be reduced. If the dog drops the bar on the open hurdle, 2 points should be reduced.

If the dog supports itself on the hurdle, the exercise is failed (0 points).

If the hurdle falls over, the exercise is failed (0 points).

If the dog anticipates the commands 2-4 points should be reduced. If it acts independently (i.e. stops before command) 2 points should be reduced.

Showing the dog directions or touching the dog at the starting point will lead to failing the exercise (0 points).

*For dropping the dumbbell and for chewing or biting on the dumbbell see the general guidelines for judging exercises.*

Figures for the recommended construction of all hurdles are at the end of these guidelines (of Part VI)

### **EXERCISE 3.9**

### **Scent discrimination and retrieve**

**[Coeff. 3]**

#### **Commands:**

("Stay/heel"), "Seek", "Release" ("Heel".)

#### **Performance:**

The handler stands at the starting point with the dog in heel position and the steward announces the start of the exercise and gives the handler a wooden retrieve object (10 cm x 2 cm x 2 cm), which has been marked beforehand with some identification. The handler can keep the marked object in her/his hands for approximately 5 sec. The dog is not allowed to touch or scent the object at this stage. The steward tells the handler to hand over the object and to turn around. The handler decides whether the dog does or does not see when the objects are positioned. Heel or stay commands are allowed. The steward walks to place the handler's object, without touching it, together with 5-7 similar objects on the ground or floor at a distance of about 10 meters from the handler. The steward places the other five to seven objects by hand and thus touches them. The objects should be placed in the same pattern for all competitors and approximately 25 cm apart, but the position of the handler's object may vary. The pattern in which the objects are placed can vary from one competition to another. There are no restrictions to placing the handler's object within the chosen pattern. See suggestions in appendix.

The handler is then told to turn around and to command the dog to retrieve the handler's marked object. The dog should find the handler's object, retrieve it and deliver it to the handler in accordance with the general directions.

The dog should be allowed to work approximately half a minute if the working is active and goal driven. All objects should be new for each competitor.

**Directions:**

Emphasis should be on the dog's willingness to work and its tempo. The exercise is failed (0 points), if the dog is allowed to scent or touch the object in the beginning of the exercise before it is handed back to the steward, if commands are given when the dog is at the objects, or if the dog picks up the wrong object. Failure is not caused if the dog scents the objects when seeking for the correct one.

*For dropping the object and for chewing or biting on the object see the general guidelines for judging exercises.*

**EXERCISE 3.10**

**Distance control**

**[Coeff. 4]**

**Commands:**

"Down" "Stay", "Sit", "Stand", "Down" and /or hand signals.

**Performance:**

The dog should change positions 6 times (sit / stand / down) according to the handler's commands and remain in its original place. A boundary is formed in back of the dog by an imaginary line connecting two markers. The handler commands, when instructed, his/her dog to lie down at the starting point in front of the boundary. The handler leaves the dog and moves to the assigned place approx. 15 m from the dog and turns around. The order of taking the positions can vary, but should be the same for all competitors. Each position should be done twice and the last command for changing position should be "down". The steward shows the handler in which order the dog should change positions, with written signs or drawings or an electric display board. The steward should stand approximately 3-5 m from the dog and so that he/she is not able to see the dog when displaying the instructions for position changes. The steward should change the sign about every 3 seconds. The handler may use both voice commands and hand signals, but they must be short and used simultaneously. After the last down command, when instructed, the handler returns to the dog and commands it to sit.

**Directions:**

Emphasis should be on the speed at which the positions are changed, the clearness of the positions and how well the positions are held and how much the dog moves. To get any points, the dog should not move in total more than its body length from the starting point in any direction. All movements are summed up (back and forth, sideways, etc.) If the dog misses one position of the six, no more than 7 points should be given. However, if the dog jumps over one position and takes the next position, the exercise is failed (0 points). The dog has to change position on command at least 5 times to get points.

If the dog sits up before the handler returns, no more than 8 points should be awarded. Extensive use of voice and exaggerated or continuous / long-lasting hand signals drop points. (See general rules.)



No more than 8 points can be awarded if the dog has to have two commands on a position change. Disobeying a second command on a position leads to missing this position. The first extra command on a position is thus -2 points and the next ones are -1 point. It is possible to get points for this exercise even if 3 – 4 of the positions have been achieved only after an extra command, if the extra commands are obeyed immediately, and lead to good, clear positions and the exercise is otherwise excellent.

## APPENDIX 1.1

Figure of the hurdles of exercises 9 in classes 1 & 2 and exercise 8 in class 3.  
The maximum height for class 1 is 50 cm and for classes 2 & 3 the maximum height is 70 cm. The sidebars should be approximately 1 m high. The feet of the hurdle should be such that the hurdle is stable. Depending on the construction of the hurdle at least 50 - 70 cm long.

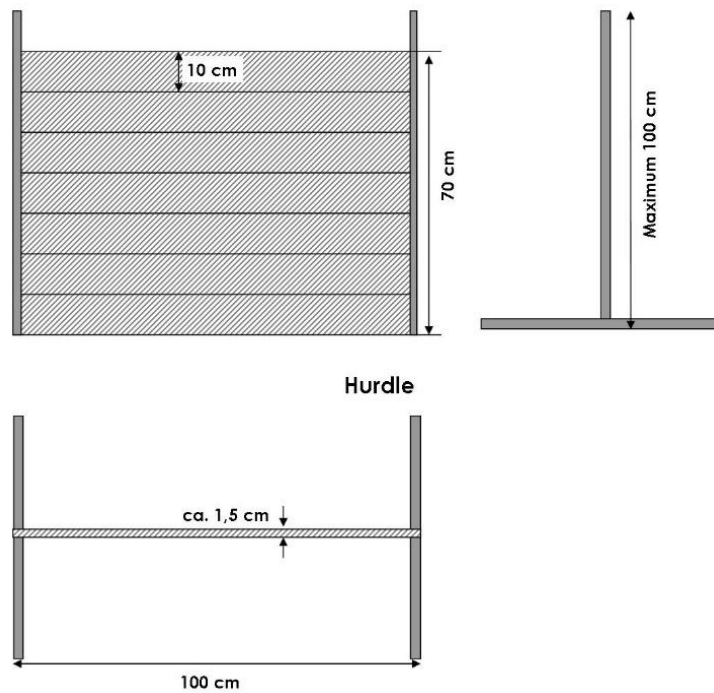

## APPENDIX 1.2

Figure of the open hurdle of exercise 8 in class 3. The bar lies freely so that it can drop to both sides. There can be a connecting thin bar at the bottom, not more than 2 cm high. It is recommended that the supports of the bar are concave so that the wind does not easily drop the bar. There should not be any extra supports for the bar, only the ones on which the bar lies.

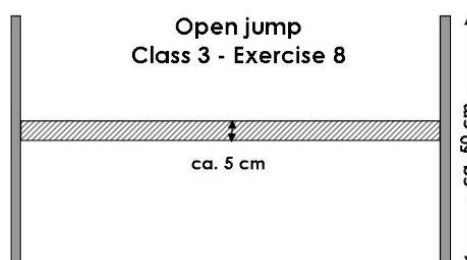
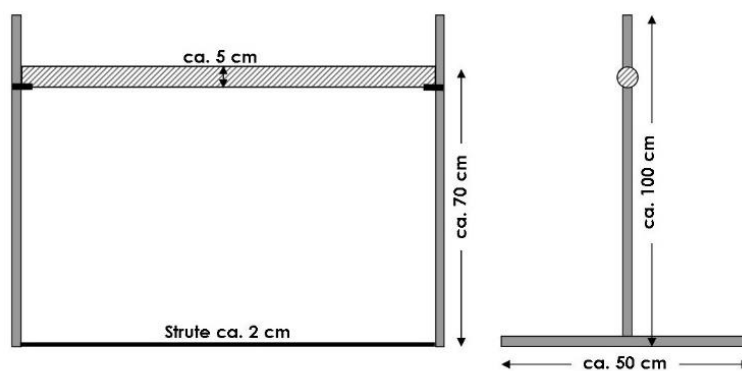

## APPENDIX 2

Suggestions for the display of the objects of exercise 9 in class 3.

